

Seismic Demand Evaluation of Elevated Reinforced Concrete Water Tanks

H. Shakib^{*1}, F. Omidinasab¹ and M.T. Ahmadi¹

Received: October 2009

Accepted: August 2010

Abstract: Elevated water tanks as one of the main lifeline elements are the structures of high importance. Since they are extremely vulnerable under lateral forces, their serviceability performance during and after strong earthquakes is a matter of concern. As such, in recent years, the seismic behavior of water tanks has been the focus of a significant amount of studies. In the present work, three reinforced concrete elevated water tanks, with a capacity of 900 cubic meters and height of 25, 32 and 39 m were subjected to an ensemble of earthquake records. The behavior of concrete material was assumed to be nonlinear. Seismic demand of the elevated water tanks for a wide range of structural characteristics was assessed. The obtained results revealed that scattering of responses in the mean minus standard deviation and mean plus standard deviation are approximately 60% to 70%. Moreover, simultaneous effects of mass increase and stiffness decrease of tank staging led to increase in the base shear, overturning moment, displacement and hydrodynamic pressure equal to 10 - 20%, 13 - 32%, 10 - 15% and 8 - 9%, respectively.

Keywords: Elevated water tank, Seismic demand, Ensemble earthquake records

1. Introduction

Elevated liquid tanks, particularly the elevated water tanks are considered as an important city services in the many flat areas. Accordingly, their serviceability performance during and after strong earthquakes is of crucial concern. The failure of these structures may cause some hazards for the health of citizens due to the shortage of water or difficulty in putting out the fire during an earthquake episode. Although many studies have been carried out on the analysis and design of ground water tanks in the past decade, only few studies have been conducted on the elevated water tanks. During the recent earthquakes, elevated tanks did not exhibit favorable seismic performance and have been suffered notable damages. Due to the failure of these lifeline elements, the emergency services such as fire fighting have been delayed, e.g., Chile 1960 [1], Izu-Oshima and Miyagi 1978 [2], San Fernando 1971, and Whittier earthquakes 1987 [3]. Elevated water tanks are heavy structures in the sense that a greater portion of their weight is concentrated at an elevation much

above their base. Critical parts of the system are the columns and beams through which the loads are transmitted to the foundation. On the other hand, initiation of any crack in the body of the tank, would limit the tank's functionality. The physical nature of the system makes it highly sensitive to the structural and the earthquake loading characteristics.

The effect of fluid interaction on the seismic response of water tanks was the subject of many studies in recent years [4-11]. However, most of them have focused on the effect of fluid interaction on the cylindrical ground water tanks, however a small number of them have concentrated on the evaluation effect of fluid interaction on the seismic response behavior of the elevated water tanks. Most of these studies have used a simplified fluid interaction model [12-18]. And some others used the finite element method as well. Livaoglu and Dogangun [7] proposed a simple analytical procedure for the seismic analysis of fluid-elevated tank-foundation-soil systems, and used this approximation in the selected tanks. Haroun and Ellaithy [19] developed a model that considers fluid sloshing modes, and assessed the effect of tank wall flexibility on the earthquake response of the elevated tanks. Marashi and Shakib [20] carried out an ambient vibration test for the evaluation of the dynamic characteristics of

* Corresponding author. Email: Shakib@modares.ac.ir

¹ Civil Engineering Department, Tarbiat Modares University, Tehran, Iran.

elevated tanks. Resheidat and Sunna [21] investigated the seismic behavior of a rectangular elevated tank. They neglected the sloshing effects on the seismic behavior of the elevated tanks. Haroun and Temraz [22] analyzed the models of two-dimensional x-braced elevated tanks supported on the isolated footings to investigate the effects of dynamic interaction between the tower and the supporting foundation-soil system. They also neglected the sloshing effects on the tanks' seismic behavior. Livaoglu and Dogangun [8, 9] conducted a comparative study on the seismic behavior of the elevated tanks with considered fluid-structure-soil interactions.

Due to the high sensitivity of elevated water tanks to such earthquake characteristics such as frequency content, peak ground acceleration and the effective duration of the earthquake records, it seems necessary to consider the earthquake loading as a non-stationary random process. A number of authors have investigated the different view points on steel and reinforced concrete elevated water tanks by using a single earthquake record [4, 6, 9, 23-25]. However, some others such as Livaoglu [8] considered two earthquake records for ground rectangular tank. Also Panchal and Jangid [26] considered six earthquake records in their investigation on the seismic behavior of steel elevated water tanks.

The nonlinear behavior of reinforced concrete elevated water tanks supported on frame type staging has been studied by Dutta et al. [24]. They observed the effect of strength deterioration of the reinforced concrete members of the tank staging under cyclic loading. Dutta et al. [24] investigated how the inelastic torsional behavior of the tank system with accidental eccentricity varies with the increasing number of panels. Dutta et al. [27, 28] studied the supporting system of elevated tanks with reduced torsional vulnerability and suggested approximate empirical equations for the lateral, horizontal and torsional stiffness for different frame supporting systems. Omidinasab and Shakib [29] studied a reinforced concrete elevated water tank under an ensemble of earthquake records using performance based-design method. Their findings revealed the vulnerability of tanks designed in accordance with the current codes.

According to the literature review, a limited number of studies have been carried out on the fluid-structure interaction and nonlinear behavior of the elevated water tanks considering the effect of earthquake characteristics. Due to uncertainty of earthquake loading and some important phenomena such as fluid-structure interaction as well as the nonlinearity effects on the system response, this study was designed aiming at evaluating the effects of fluid-structure interaction, also assumed concrete nonlinear behavior of the elevated water tanks subjected to an ensemble of earthquake records. In addition, seismic demand of the reinforced concrete elevated water tanks was assessed for a wide range of structural characteristics.

2. Description of the Elevated Tanks

Three reinforced concrete elevated tanks with different elevation of support systems were employed in this study. They were placed on the framed structure with the capacity of 900 cubic meters and the height of 25, 32 and 39 m. In this study, the above mentioned tanks were named as tank No.1 (tank with 13 m staging height), tank No. 2 (tank with 20 m staging height) and tank

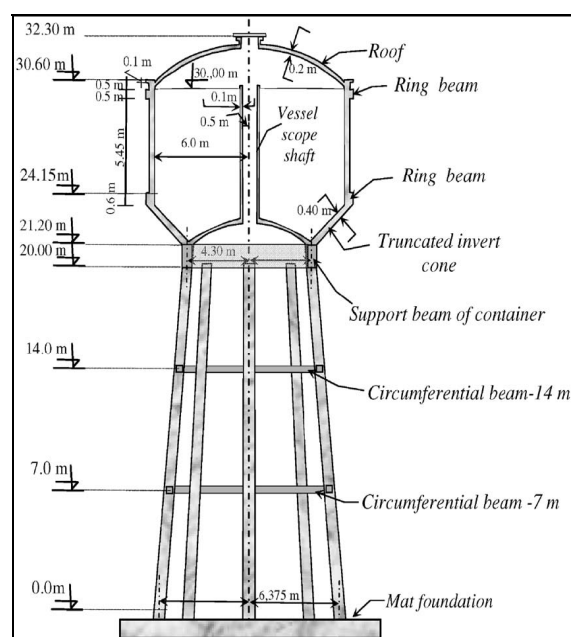

Fig. 1. Details and elevation of the tank No. 2 [9].

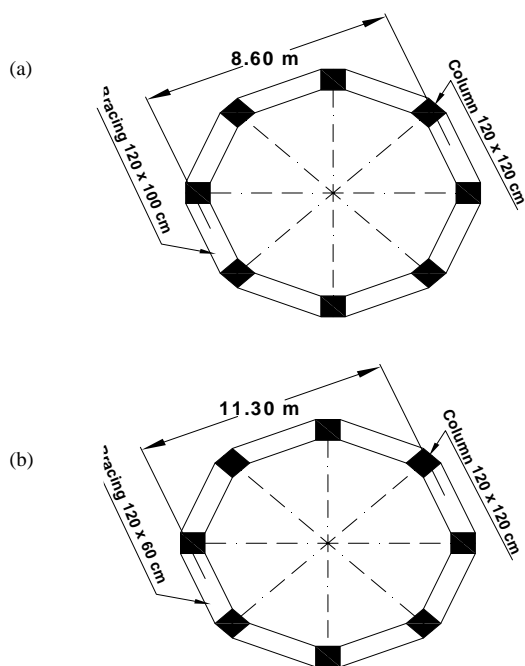

Fig. 2. (a) Arrangement of the columns and beams under the tank container; (b) Arrangement of the columns and beams on the first storey

No. 3 (tank with 27 m staging height), respectively. Tank No. 2 is shown in Figs. 1 and 2. Since the tank vessel is Intze, hence, there is a symmetry in the loading and shape of the vessel. This type of tank and supporting system has been widely used in the recent years around the world. It is worth noting that the staging and vessel are loading according to ASCE7-05 and UBC-97 codes and designed according to ACI-318-99 code. Also, detailed specifications of these tanks and the material properties considered for the steel, concrete and water are provided in Table 1.

3. Modeling of the Elevated Water Tanks

Finite element model was employed to model elevated water tanks system. The behavior of concrete material was considered to be nonlinear. Also the tank fluid and staging system were modeled as finite element. More details are as.

3.1. Fluid-Structure System Modeling

As shown in Fig. 3, columns and beams in the support system were modeled as beam elements (with three nodes and with six degrees-of-freedom per node). There is likely that the potential of forming plastic joint in each point of the element. In order ensure the probability of plastic hinge formation in the middle of beam, each beam and column of the staging was modeled with three elements. In addition, the truncated cone and container walls were modeled with triangle and quadrilateral shell elements (with three and four nodes and six degrees-of-freedom per node). Water was modeled with acoustic cubic elements (with eight nodes and three degrees-of-freedom per node).

Fluid-structure interaction problems can be investigated by using different techniques such as Added Mass (AM) [12-16], Lagrangian Method (LM) [30], Eulerian Method (EM) [31-34], and Lagrangian-Eulerian Method (L-E M) [35] approaches in the Finite Element Method (FEM) or by the analytical methods like Housner's two-mass [14] representation, multi-mass representation of Bauer [34] and EC-8 [37]. In this study, displacement based Lagrangian approach was used to model the fluid-elevated

Table 1. Tank and material properties.

Tank vessel properties (m)		Tanks staging properties (m)			
	Dimensions		No. 1	No. 2	No. 3
Vessel volume	900 m ³	Columns dimensions	1.10 × 1.10	1.20 × 1.20	1.35 × 1.35
Inner diameter	12	Columns height	7+6 = 13	7+7+6 = 20	7+7+7+6 = 27
Height	10.6	Staging inner diameter in the top	8.60	8.60	8.60
Top ring beam	0.6 × 0.6	Staging inner diameter in the bottom	11.30	12.75	14.20
Bottom ring beam	0.8 × 0.6	Beams dimensions in first floor	1.10 × 0.40	1.20 × 0.60	1.35 × 1.10
Roof thickness	0.20	Beams dimension in second floor	1.10 × 0.80	1.20 × 0.60	1.35 × 0.70
Vessel thickness	0.40	Beams dimension in third floor	-----	1.20 × 1.0	1.35 × 0.70
Bottom slab thickness	0.50	Beams dimension in fourth floor	-----	-----	1.35 × 1.0
Material property					
Concrete		Steel		Water	
E (MPa)	2.6 × 10 ⁴	E (MPa)	2.1 × 10 ⁵	Density (KN/m ³)	10
f _c ' (MPa)	30	F _y (MPa)	240	Bulk module (GPa)	2.10
Weight of volume unit (KN/m ³)	25	Weight of volume unit (KN/m ³)	78.5	-----	-----

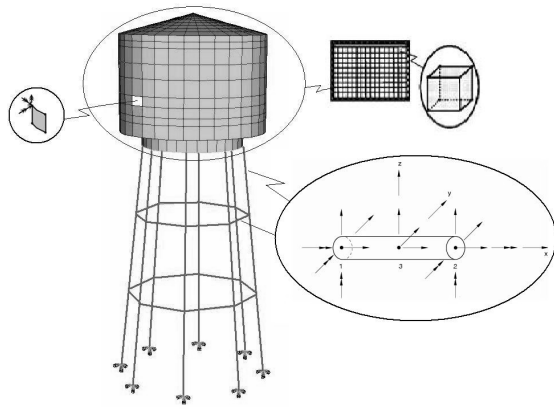

Fig. 3. Finite element model of the fluid-elevated tank system.

tank interaction. The fluid elements were defined by eight nodes with three translational degrees-of-freedom at each node. It should be noted that, due to the lack of a geometrical capability in the Lagrangian FEM with brick shaped elements considered here, Intze-type was idealized as a cylindrical vessel that has the same capacity with the intze type. Each brick fluid element includes special surface effects, which may be thought of as gravity springs used to hold the surface in place. This was performed by adding springs to each node, with the spring constants being positive on the top of the element. For an interior node, the positive and negative effects were canceled out. The positive spring stiffness can be expressed as [9]:

$$K_s = \rho A_f (g_x C_x + g_y C_y + g_z C_z) \quad (1)$$

Where, ρ is the mass density, A_f is the area of

the element face, g_i and C_i are acceleration in the i direction and i^{th} component of the normal to the element face, respectively. Expressions for mass (M_f) and rigidity matrices (K_f) of fluid are given below [9]:

$$M_f = \rho \int_V Q^T Q dV = \rho \sum_i \sum_j \sum_k \eta_i \eta_j \eta_k Q_{ijk}^T Q_{ijk} J_{ijk} \quad (2)$$

$$K_f = \int_V B^T E B dV = \sum_i \sum_j \sum_k \eta_i \eta_j \eta_k B_{ijk}^T E B_{ijk} \det J_{ijk} \quad (3)$$

Where, J is the Jacobian matrix, Q_{ijk} is the interpolation function, η_i , η_j , η_k are the weight functions, and B is the strain-displacement matrix obtained from $\varepsilon = Bu$, where kinetic (T) and potential energy equations (U) can be written as [9]:

$$U = \Pi_\varepsilon \rightarrow U = \frac{1}{2} u^T K_f u \quad (4)$$

$$T = \frac{1}{2} v^T M_f v \quad (5)$$

If the expressions for the kinetic and potential energies are substituted into the Lagrange equation, then:

$$\frac{d}{dt} \left(\frac{\partial T}{\partial \dot{u}_j} \right) - \frac{\partial T}{\partial u_j} + \frac{\partial U}{\partial u_j} = F_j \quad (6)$$

Where, u_j is the j^{th} displacement component and F_j is the applied external load. Then the governing equation can be written as:

$$M_f \ddot{u} + (K_f + K_s) u = R \quad (7)$$

Where, \ddot{u} is the acceleration and R is a time varying load vector.

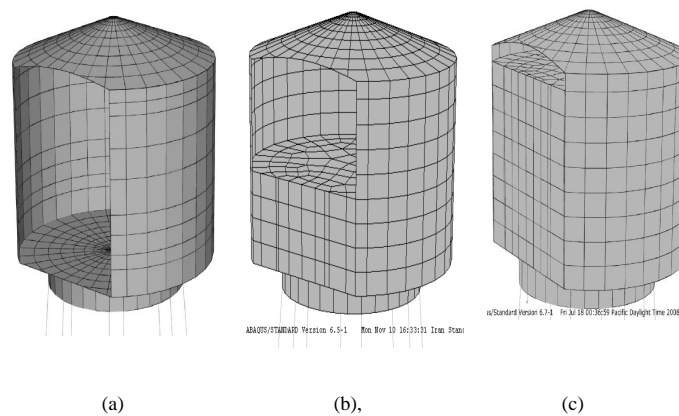

Fig. 4. Modeling of the tank vessels in finite element software: a) empty case; b) half-full case; c) full case.

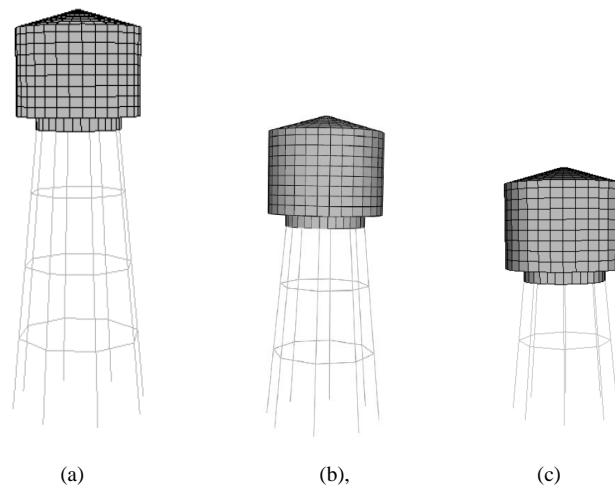

Fig. 5. Modeling of the tanks in finite element software: a) No. 1; b) No. 2; c) No. 3.

Figure 4 shows modeling of vessel in different cases of tank fullness percent and Fig. 5 shows the final model of tanks with staging for different levels of fluid and:

3.2. Modeling of the Material's Nonlinear Behavior

Concrete is a material whose tension and compression behavior have significant differences. Many researchers have attempted to present a mathematical model of this type of material on the basis of experimental results and, as such, different models have been proposed. In this study, Park and Kent model was considered [38]. Kent and Park [38] proposed a model, in which a mathematical relation on the stress-strain behavior of concrete was considered. This model was later developed by Scott et al in 1982 [39] and employed by many researchers in the bending frames [39, 40]. In this paper, the values of uniaxial compressive stress (f'_c), modulus of elasticity (E_c) and Poisson's ratio (ν) were assumed to be equal to 300 kg/cm², 26.15 GPa and 0.20, respectively. Therefore, the stress-strain curves of concrete for confinement and non-confinement conditions were obtained and illustrated in Fig. 6. In this figure, uniaxial compressive yield stress and the tensile yield stress versus strain were plotted. Also, the figure illustrates the evolution of tensile yield stress versus strain. The plastic strain associated with a total loss of load-carrying capacity of the material in tension was about 0.0035. An elasto-perfectly

plastic constitutive law by Von-Mises was assumed to model the reinforcement behavior with $E_s = 210$ GPa, $\nu = 0.3$ and $f_{yd} = 387$ (yield stress) respectively. Bond-slip between the concrete and reinforcement was neglected. Rayleigh damping was used in the analyses. For columns, the concrete confinement model and for the beams and shells, the un-confinement concrete model was used.

4. Ground Motions

To evaluate the dynamic response of the elevated tanks, three cases of empty, half-full, and full filling levels were considered. The time history analyses were carried out by using the above-mentioned system and equations. For performing nonlinear time history analysis, the tank was assumed to be located in soil type C

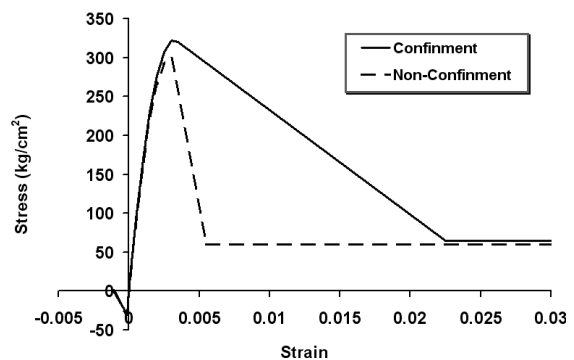

Fig. 6. Concrete strain-stress curves in the obtained strain and stress behaviors based on Kent and Park relation.

Table 2. Details of the ground motions selected for the study.

Number	Record	Year	Component	Station	PGA (g)	PGV (cm/s)	PGD (cm)	Duration (sec)	Closest to fault rupture (Km)	M
1	Duzce, Turkey	1999	BOL - 00	Bolu	0.728	56.4	23.07	55.90	17.60	7.1
			BOL - 90	Bolu	0.822	62.1	13.55	55.90	17.60	7.1
2	Landers	1992	YER - 270	Yermo Fire	0.245	51.5	43.81	44.98	24.90	7.3
			YER - 360	Yermo Fire	0.152	29.7	24.69	44.98	24.90	7.3
3	Loma Prieta	1989	G04 - 00	Gilroy Array #4	0.417	38.8	7.09	40.95	16.10	6.9
			G04 - 90	Gilroy Array #4	0.212	37.9	10.08	40.95	16.10	6.9
4	Morgan Hill	1984	G02 - 00	Gilroy Array #2	0.162	5.1	1.42	30.98	15.10	6.2
			G02 - 90	Gilroy Array #2	0.212	12.6	2.1	30.98	15.10	6.2
5	Northridge	1994	CNP - 106	Canoga Park –Topanga Can	0.356	32.1	9.13	25.98	15.80	6.7
			CNP - 196	Canoga Park –Topanga Can	0.420	60.8	20.17	25.98	15.80	6.7
6	Superstitt Hills	1987	B-CAL - 225	Calipatria Fire	0.18	15.5	3.3	23.24	28.30	6.7
			B-CAL - 315	Calipatria Fire	0.247	14.6	3.1	23.24	28.30	6.7
7	Whittier Narrows	1987	A-CAS - 00	Compton – Castlegate Street	0.332	27.1	5.04	32.16	16.90	6.0
			A-CAS - 270	Compton – Castlegate Street	0.333	14.1	1.48	32.16	16.90	6.0

according to UBC-97 soil category. An ensemble of earthquake records that contains seven pairs of earthquake records was used to investigate the response behavior of the system. The specifications of each record are shown in Table 2. In order to scale the records, the UBC-97 procedures was used and scaled on the basis of the structure’s period between 0.2T and 1.5T; where T is the fundamental period of the structure. The original and scaled spectra of horizontal components of Landers earthquake are shown as an example in the Fig. 7. As it is shown in Table 2, the maximum PGA and PGV values of the selected earthquake records are related to Duzce ground motion and are equal to 822 cm/s² and 62.1 cm/s, respectively.

5. Free Vibration Analysis

To define the dynamic characteristics of the

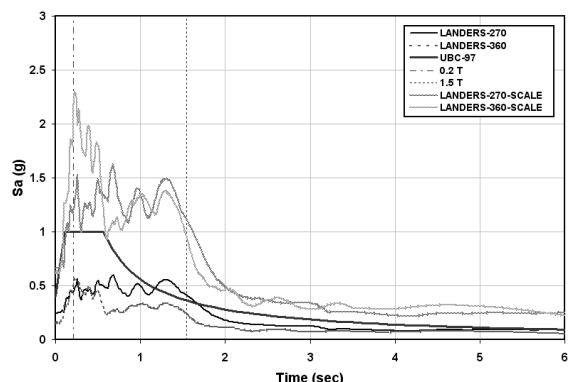

Fig. 7. Response spectra of Landers earthquake horizontal components in 5% damping, scaling and UBC spectrum.

elevated water tanks and determine the seismic behavior of the system, first, free vibration analysis was carried out. The dynamic characteristics of tanks including period and the effective modal mass ratio are shown in Table 3. The table shows sum of the first eight modes that covers more than 90 % of the total mass of the system. For example, the main modes in full filling for tank No. 3 are shown in Fig. 8. By this analysis, sum of the structure’s first eight modes partnership is more than 90 %. The first and second modes are related to the convective and the third to eighth modes associated with the structures modes.

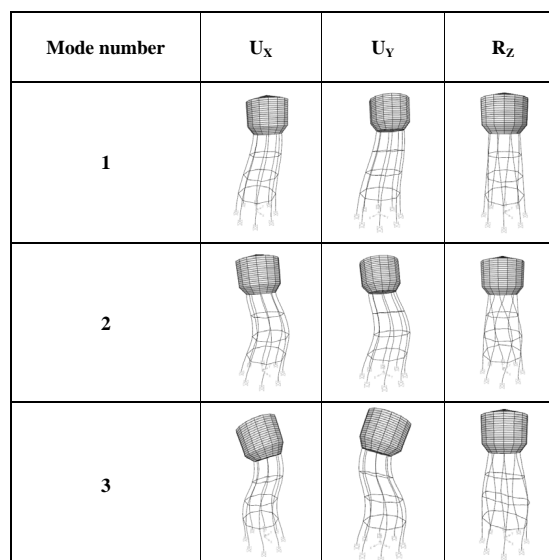

Fig. 8. Mode shapes of the elevated water tank No. 3 for full filling level.

Table 3. Period and effective modal mass ratio of the tanks.

Tank No. 1												
Mode No.	Full Case				Half-Full Case				Empty Case			
	T (sec)	U _X	U _Y	R _Z	T (sec)	U _X	U _Y	R _Z	T (sec)	U _X	U _Y	R _Z
1 [†]	3.670	0.051	0.041	0.000	4.028	0.025	0.066	0.000	-----	-----	-----	-----
2 [†]	3.670	0.041	0.051	0.000	4.028	0.066	0.025	0.000	-----	-----	-----	-----
3	0.653	0.310	0.565	0.000	0.597	0.305	0.566	0.000	0.573	0.358	0.598	0.000
4	0.653	0.565	0.310	0.000	0.597	0.566	0.305	0.000	0.572	0.598	0.358	0.000
5	0.531	0.000	0.000	0.942	0.530	0.000	0.000	0.941	0.529	0.000	0.000	0.941
6	0.135	0.001	0.000	0.000	0.128	0.001	0.000	0.000	0.137	0.001	0.000	0.000
7	0.133	0.000	0.001	0.000	0.126	0.000	0.001	0.000	0.134	0.000	0.001	0.000
8	0.091	0.000	0.000	0.058	0.091	0.000	0.000	0.058	0.091	0.000	0.000	0.058
Sum		0.968	0.968	1.00	-----	0.963	0.963	0.999	-----	0.957	0.957	0.999
Tank No. 2												
1 [†]	3.678	0.043	0.040	0.000	4.035	0.022	0.057	0.000	-----	-----	-----	-----
2 [†]	3.678	0.040	0.043	0.000	4.035	0.057	0.022	0.000	-----	-----	-----	-----
3	1.016	0.338	0.504	0.000	0.941	0.346	0.492	0.000	0.908	0.391	0.515	0.000
4	1.015	0.504	0.339	0.000	0.940	0.492	0.346	0.000	0.907	0.515	0.391	0.000
5	0.715	0.000	0.000	0.862	0.714	0.000	0.000	0.862	0.713	0.000	0.000	0.862
6	0.196	0.021	0.006	0.000	0.190	0.026	0.007	0.000	0.192	0.024	0.008	0.000
7	0.195	0.007	0.022	0.000	0.189	0.008	0.027	0.000	0.191	0.009	0.026	0.000
8	0.156	0.000	0.000	0.115	0.156	0.000	0.000	0.115	0.156	0.000	0.000	0.115
Sum		0.953	0.954	0.977	-----	0.951	0.951	0.977	-----	0.939	0.94	0.977
Tank No. 3												
1 [†]	3.680	0.036	0.035	0.000	4.038	0.019	0.048	0.000	-----	-----	-----	-----
2 [†]	3.680	0.035	0.036	0.000	4.038	0.048	0.019	0.000	-----	-----	-----	-----
3	1.139	0.305	0.464	0.000	1.088	0.319	0.443	0.000	1.028	0.344	0.464	0.000
4	1.138	0.464	0.305	0.000	1.087	0.443	0.319	0.000	1.027	0.464	0.344	0.000
5	0.745	0.000	0.000	0.713	0.772	0.000	0.000	0.716	0.743	0.000	0.000	0.712
6	0.253	0.055	0.019	0.000	0.252	0.062	0.023	0.000	0.247	0.066	0.023	0.000
7	0.252	0.019	0.056	0.000	0.252	0.023	0.063	0.000	0.246	0.024	0.067	0.000
8	0.196	0.000	0.000	0.193	0.201	0.000	0.000	0.194	0.196	0.000	0.000	0.193
Sum		0.914	0.915	0.906	-----	0.914	0.915	0.91	-----	0.898	0.898	0.905

[†]The first and second modes in full and half-full cases are related to convective modes.

6. Seismic Demand Evaluation

In this study, nonlinear time history analysis was used to determine seismic behavior of the elevated water tanks. It was assumed that earthquake acceleration is simultaneously applied to the tank in two perpendicular horizontal directions. The system was examined in three cases, i.e. empty, half-full and full filling tanks. The results are discussed in the following paragraphs.

Table 4 shows the maximum responses of the system for the above-mentioned cases. These responses include base shear, overturning moment, bottom slab displacement and hydrodynamic pressure of the system. The maximum response was determined for different parameters of the elevated water tanks subjected to seven pairs of the records earthquake acceleration.

7. Effect of Frequency Content

The effects of frequency content of the

earthquake records were investigated on the system responses. Figure 9 shows the Fourier amplitude versus frequency for the longitudinal and transverse earthquake records of Duzce. In order to show the system's the range of the frequency content, the natural frequencies of empty and full filling of the elevated water tanks are also presented. The results showed that the frequency content of Duzce earthquake record

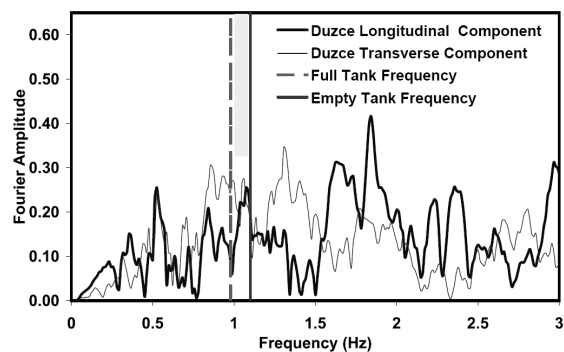

Fig. 9. Frequency content of Duzce earthquake record and frequency domain of the tank No. 2 in full, half full and empty filling cases.

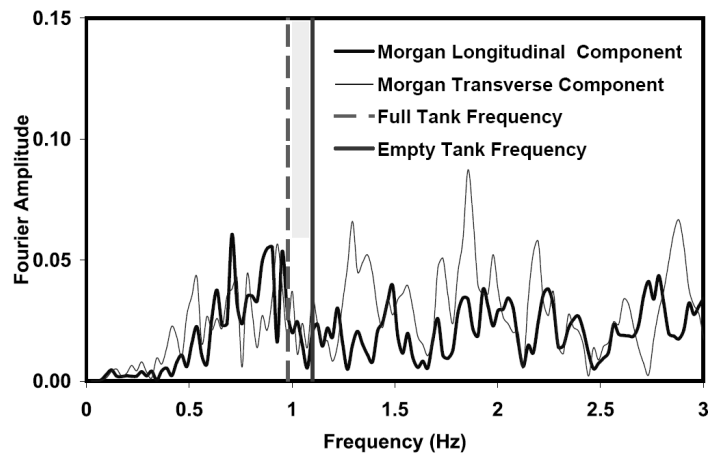

Fig. 10. Frequency content of Morgan Hill earthquake record and frequency domain of the tank No. 2 in full, half full and empty filling cases.

was high within the frequency range of natural system, causing resonance in the responses. While, for Morgan Hill earthquake record, due to the low amplitude of the frequency content within the frequency range of natural system, the responses were considerably reduced (Fig. 10).

8. Dispersion of the Seismic Demand of Tanks for Earthquake Records

Dispersion of the tank seismic's demands including base shear force, overturning moment; slab displacement and hydrodynamic pressure of the system subjected to seven pairs of earthquake

Table 4. Evaluation of the tanks seismic demands.

Tank No. 1													
Number	Record	Base Shear force (KN)			Overt. Moment (KN.m)			Slab Displa. (cm)			Hydr. Pressure (KPa)		
		$H_{water}^{\dagger} / H_{vessel}^{\ddagger}$			H_{water} / H_{vessel}			H_{water} / H_{vessel}			H_{water} / H_{vessel}		
		1.0	0.5	0.0	1.0	0.5	0.0	1.0	0.5	0.0	1.0	0.5	0.0
1	Duzce	5053	4755	2164	25867	42483	15698	23.54	23.35	19.04	27.13	23.87	0.00
2	Landers	4822	5554	1670	21116	34497	13916	19.57	21.46	15.07	21.62	22.37	0.00
3	Loma Prieta	3754	3229	1055	22898	27151	12850	13.96	13.70	8.22	16.17	14.28	0.00
4	Morgan Hill	1926	1420	831	19136	21721	8039	12.00	11.28	9.39	9.46	6.11	0.00
5	Northridge	2487	4347	2164	23228	40566	8981	21.72	20.35	18.72	13.18	8.27	0.00
6	Superstitt Hills	4374	4312	1874	19136	21721	10444	20.80	18.00	16.17	17.53	19.04	0.00
7	Whittier Narrows	3345	4383	1442	24547	21082	11372	16.30	19.30	12.91	20.32	16.75	0.00
Average – Standard Deviation		2505	2671	1079	19680	20648	8886	14.00	13.90	9.95	12.12	9.07	0.00
Average		3680	4001	1603	22276	29889	11614	18.27	18.21	14.22	17.92	15.81	0.00
Average + Standard Deviation		4855	5329	2121	24871	39130	14342	22.54	22.51	18.48	23.71	22.55	0.00
Tank No. 2													
1	Duzce	6627	5602	1770	28065	60984	14315	39.41	27.51	20.38	24.27	22.93	0.00
2	Landers	5548	5511	1822	28910	49413	13850	33.14	27.47	19.87	22.63	21.16	0.00
3	Loma Prieta	3570	4349	2755	26797	18764	21299	23.32	29.04	23.61	12.61	11.94	0.00
4	Morgan Hill	1471	2168	830	15681	10633	7681	14.05	9.67	9.31	7.01	6.39	0.00
5	Northridge	2581	4655	1498	26797	30648	12104	19.72	23.00	14.80	11.18	8.65	0.00
6	Superstitt Hills	4010	4009	2511	19020	51289	14548	22.63	19.54	22.46	17.50	16.51	0.00
7	Whittier Narrows	5132	4506	2253	31108	50038	23743	27.84	22.09	21.55	15.74	14.05	0.00
Average – Standard Deviation		2352	3253	1267	19558	19902	9899	17.23	15.96	13.79	9.66	8.38	0.00
Average		4134	4401	1920	25197	38824	15363	25.73	22.62	18.85	15.85	14.52	0.00
Average + Standard Deviation		5916	5547	2573	30835	57746	20827	34.24	29.28	23.92	22.04	20.66	0.00
Tank No. 3													
1	Duzce	7648	6460	2829	44372	65267	20488	36.35	33.65	25.65	23.42	22.51	0.00
2	Landers	5789	5107	2568	49983	61155	24384	32.70	29.48	25.65	20.35	19.68	0.00
3	Loma Prieta	3675	5349	2503	42153	37290	22642	30.78	31.00	24.61	14.71	13.47	0.00
4	Morgan Hill	1865	2499	1196	22555	28512	10729	16.35	14.35	11.13	7.95	5.18	0.00
5	Northridge	4322	3589	1679	35106	43970	13342	20.00	19.83	14.96	11.55	10.84	0.00
6	Superstitt Hills	5072	4608	2169	39674	33561	21542	27.83	25.39	20.70	15.89	15.26	0.00
7	Whittier Narrows	2430	4308	1895	37645	52206	15954	26.43	23.13	17.74	17.08	14.71	0.00
Average – Standard Deviation		2409	3283	1550	30153	31970	13302	20.17	18.50	14.37	10.67	8.85	0.00
Average		4405	4560	2120	38784	45994	18440	27.21	25.26	20.06	15.85	14.52	0.00
Average + Standard Deviation		6391	5837	2690	47415	60018	23579	34.25	32.02	25.76	21.03	20.19	0.00

H_{water}^{\dagger} : Water height in the vessel; H_{vessel}^{\ddagger} : Vessel height

records have been investigated. In order to show the dispersion of the results mean plus standard deviation and mean minus standard deviation of the responses calculated. Therefore, mean, mean plus standard deviation and mean minus standard deviation of the responses calculated. Also, maximum and minimum values of the responses are shown in the Figs. 11-14.

The variation of maximum, minimum, mean and one plus and one minus standard deviation values of base shear forces versus the percentage of the storage tank filling are presented in the Fig. 11, for the systems. As it can be clearly observed, in the case of empty storage tank, dispersion of base shear is small. The dispersion is increased when the filling percentage in the storage tanks is increased. The increased dispersion is not linear with the amount of the filling percentage. This increase mainly depends on the system characteristics. According to Fig. 11, the maximum dispersion occurs when the storage tank is in half-full filling condition. However, as shown in Figs. 11-b and 11-c, the maximum dispersion happens when the storage tanks are

full. It is of interest to mention that dynamic characteristics of the system and hydrodynamic effects considerably affect the amount of base shear forces.

The variations of maximum, minimum, mean and one plus and one minus standard deviation values of overturning moment versus the percentage of storage tank filling are presented in the Fig. 12 for all the systems. The dispersion of overturning moment is small for all the systems when the storage tanks are empty and full filling case. The maximum dispersion is related to the half-full storage tank. The pattern of overturning moment variation is almost the same for the systems with different characteristics. However, it should be noted that fluid-structure interaction considerably influenced the dispersion when the tanks are half-full.

The variation dispersion of slab displacement versus the percentage of filling is shown in the Fig. 13 for all the systems. As can be seen, dispersion increases linearly with the increase in the percentage of filling. However, as shown in Figs. 13-a, 13-b and 13-c, maximum dispersion

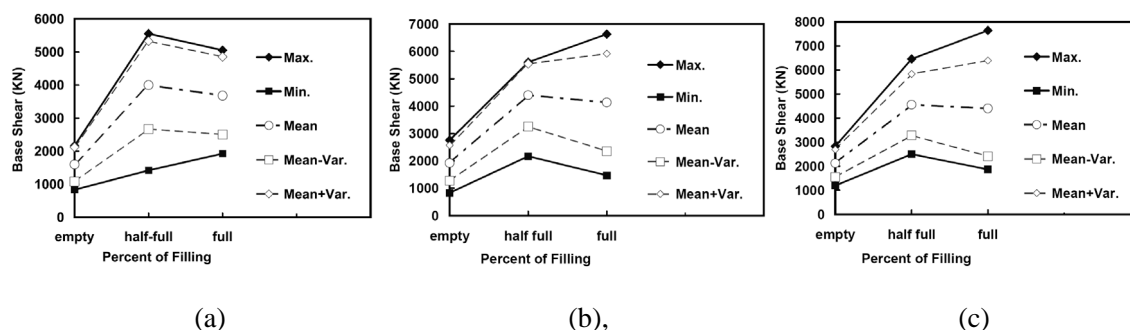

Fig. 11. The variation distribution of base shear forces based on fullness percent of tank: a) No. 1; b) No. 2; c) No. 3.

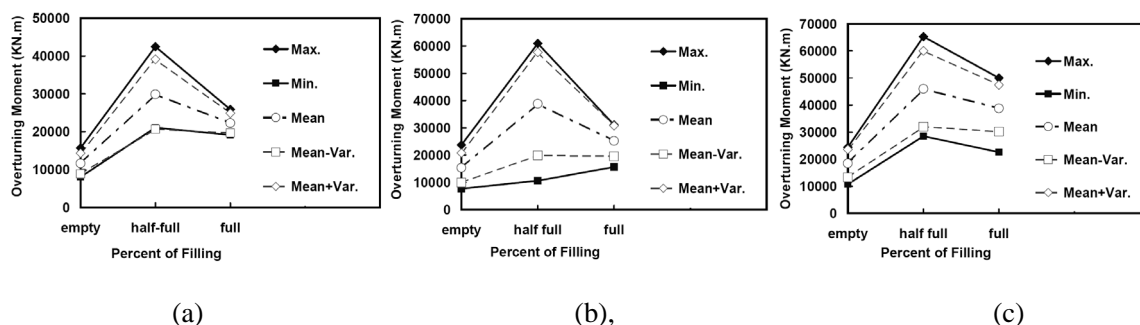

Fig. 12. The variation distribution of overturning moment based on fullness percent of tank: a) No. 1; b) No. 2; c) No. 3.

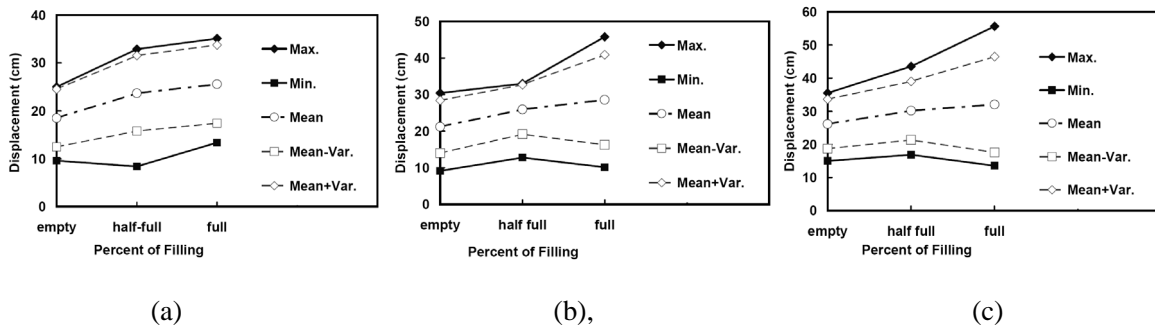

Fig. 13. The variation distribution of displacement based on fullness percent of tank: a) No. 1; b) No. 2; c) No. 3.

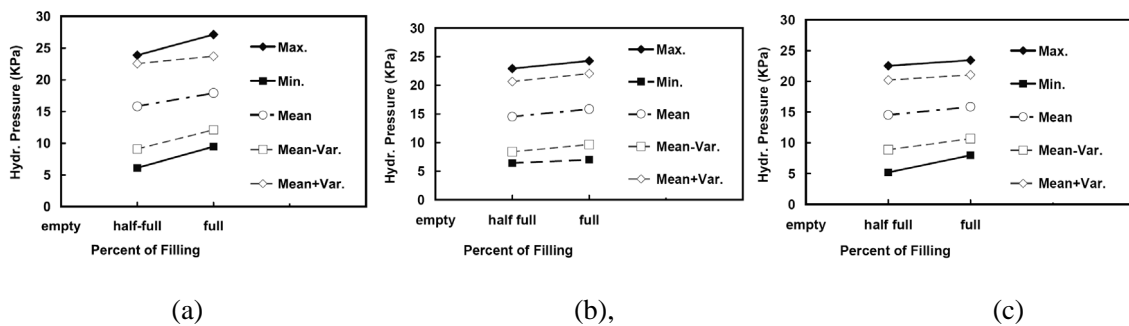

Fig. 14. The variation distribution of hydrodynamic pressure based on fullness percent of tank: a) No. 1; b) No. 2; c) No. 3.

occurred in the full storage tanks.

The variation of hydrodynamic pressure versus the percentage of storage tank filling is presented in Fig. 14 for all the systems. The dispersion increases linearly as the percentage of filling in the storage tanks increases. However, shown in Figs. 14-a, 14-b and 14-c, the maximum dispersion happens when the storage tanks are full.

The above figures show that the major system responses such as base shear, overturning moment, slab displacement and hydrodynamic pressure are highly scattered. The maximum scattering for base shear, overturning moment, slab displacement and hydrodynamic pressure is about 4.5, 5.7, 4.6, and 4, respectively. This shows the system is vastly influenced by the characteristics of earthquake records. For the design of such system, should not be considered as an ergodic random process and the earthquake records must be considered as a non-stationary random process.

9. Seismic Demands of the Systems

Seismic demands of three elevated water tanks were determined for a range of period and the percentage of fullness and discussed as the following:

(i). Base Shear

Figure 15 shows variation of base shear forces versus the percentage of filling and periods for three elevated water tanks. The means of the maximum time history of the base shear forces are presented as well. The variation of base shear forces over the percentage of filling showed that the maximum of base shear forces happens for the half-full filling. Its means may be due to that the hydrodynamic pressures for half-full filling is more compared to full filling tanks. The pattern of variation for all the three tanks is the same.

Table 5, shows the comparison of the stiffness and mass of the tanks No. 2 and No. 3 with the tank No. 1. The stiffness of tanks No. 2 and No.

Table 5. Comparison of the mass and stiffness in three elevated water tanks.

	Tank No. 1			Tank No. 2			Tank No. 3		
	Case of filling			Case of filling			Case of filling		
	Full	Half-Full	Empty	Full	Half-Full	Empty	Full	Half-Full	Empty
Mass (KN)	19372	14875	10371	21910	17413	12918	24248	19744	15249
Mass increase percent (%)	0	0	0	13	17	25	25	33	47
Stiffness (KN/m)	197278			103627			86207		
Stiffness decrease percent (%)	0			47			56		

3 have decreased by 47% and 56%, respectively compared to the tank No. 1. Also, the mass of tanks No. 2 and No. 3 compared to tank No. 1 have increased by 24%, 17%, 13% and 47%, 33% and 25% for the empty, half-full and full filling, respectively.

Variation of base shear force versus the natural period for the systems with empty, half-full and full filling is shown in Fig. 15-b. As the period increases, the base shear force also increase for all the cases. However, the rate of increase is not considerably high. The interesting point is that the half-full filling has higher base shear forces compared to the full filling.

As shown in Fig. 15-a, comparison base shear forces of the tanks No. 2 and No. 3 with the tank No. 1 shows that base shear force increased by 20%, 10% and 12% for empty, half-full and full filling cases, respectively in the tank No. 2. Also these increases correspond with the values of 33%, 14% and 20% for empty, half-full and full filling, respectively in the tank No. 3. It is clear that the simultaneous effects of increase and decrease in the stiffness of tank staging and tank

mass (Table 5) respectively, lead to an increase in the base shear force. Considering the fact that these affect lead to increase in the structure period, it is concluded that increase in the tank period occurs in the range of spectrum constant velocity and this in turn causes reduction in energy absorption by structural system and consequently results in the increase in the tank's base shear force. As can be seen clearly shown in Fig. 15, the increase of base shear in the half-full case is less than that in the empty and full cases. This can be assigned to the effects of sloshing modes of the fluid that causes reduction in the base shear. In the current study, the effects of structure-fluid interaction were modeled using finite element method and also the effects of fluid sloshing were considered.

(ii). Overturning Moment

Figure 16 shows the variation of overturning moment versus the percentage of fullness and periods for the three elevated water tanks. The means of the maximum time history of the

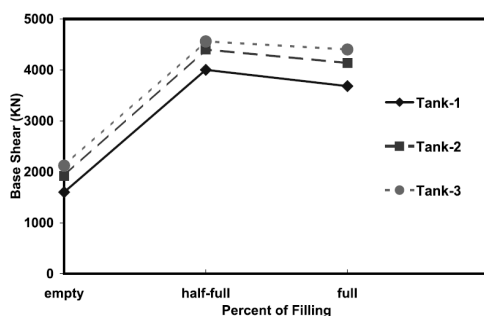

(a)

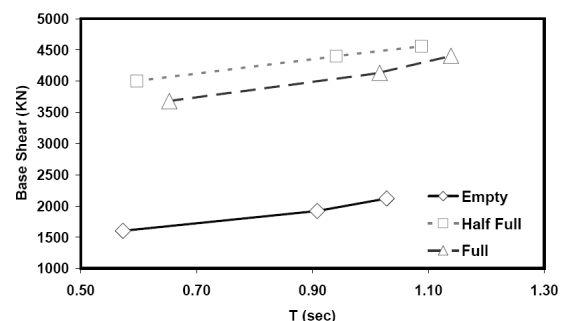

(b)

Fig. 15. Variations comparison of base shear forces in the tanks No. 1, 2 and 3 based on: a) fullness percent; and b) Period.

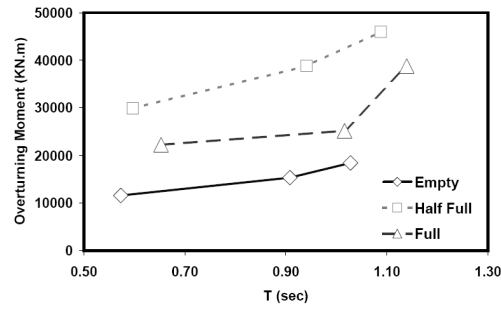
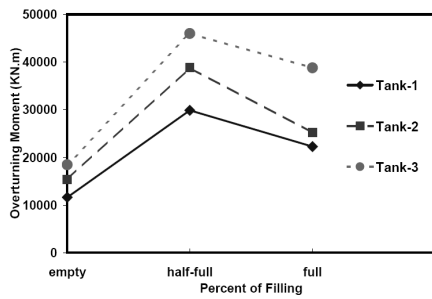

(a) (b)
Fig. 16. Variations comparison of overturning moment in the tanks No. 1, 2 and 3 based on:
 a) fullness percent; and b) Period.

overturning moment are presented as well. The variations of overturning moment over the percentage of filling show that the maximum of overturning moment happens for the half-full filling. The reason is that the hydrodynamic pressure in the half-full filling tanks is more in the full filling tanks. The same pattern of variations can be seen in all the three tanks. Variation of overturning moment versus the natural period for the systems with empty, half-full and full filling cases is shown in Fig. 16-b. Increase in the period leads to increase in the overturning moment in all the cases. However, the slope of increase is considerably high. The interesting point is that the half-full filling case has higher overturning moment as compared to the full filling. Overturning moment of the tanks No. 2 and No. 3 is compared with the tank No. 1 in Fig. 16-a. The figure implies that overturning moment has increased by 32%, 30% and 13% for the empty, half-full and full filling cases, respectively in the tank No.2. Also these increases correspond with the values of 59%, 54% and 74% for the empty, half-full and full filling cases, respectively in the tank No.3.

As stated previously, simultaneous effects of mass increase and stiffness decrease of tank staging (Table 5) that lead to increase in the overturning moment, is more critical in the half-full case. In addition, the height of the tanks No. 2 and No. 3 has increased by 28% and 56% as compared to the tank No.1. Based on what mentioned above, it is concluded that overturning moment is more critical in the half-full case and simultaneous effects of mass increase and stiffness decrease of tank staging lead to increase

in the overturning moment. Comparison of the cases in which interaction is considered (full and half-full tanks) with the case in which interaction is not considered (empty tank) showed that the effects of fluid-structure interaction result in decrease in the base shear force and overturning moment.

(iii). Displacement

Figure 17 shows the variation of displacement versus the percentage of fullness and periods for the three elevated water tanks. The means of the maximum time history of displacement are presented as well. The variations of displacement the percentage of filling show that the maximum of displacement happens for the full filling case. This pattern of variations is the same for all the three tanks. Variation of displacement versus the natural period for the systems with empty, half-full and full filling cases is shown in Fig. 17-b. Increase in the natural period results in the increases in the displacement for all the cases. However, the slope of increase is considerably high. Comparison of the displacements of the tanks No. 2 and No. 3 with the tank No. 1 shown in Fig. 17-a indicated that displacement has increased by 15%, 10% and 12% for the empty, half-full and full filling cases, respectively in the tank No.2. Also these increases correspond with the values of 42%, 28% and 25% for the empty, half-full and full filling cases, respectively in the tank No. 3.

The increase in the displacement of the tanks No. 2 and 3, as compared to the tank No. 1 can be attributed to the effects of increase in the mass

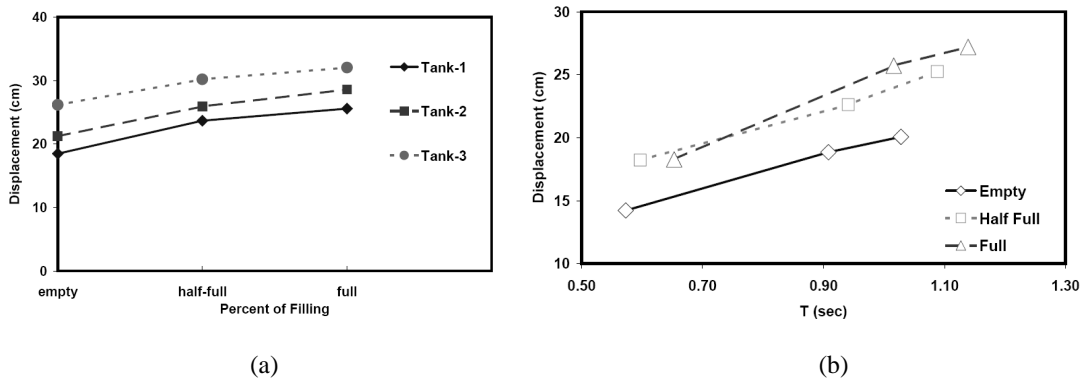

Fig. 17. Variations comparison of displacement in the tanks No. 1, 2 and 3 based on: a) fullness percent; and b) Period.

and height of the tank. As shown in Fig. 17, the slope of displacement increase in range of half-full to full tanks is less than that of in the range of empty to half-full tanks. This is due to the effects of fluid sloshing and fluid modes. On the other hand, the evaluation of tank displacement in the range of elastic and plastic showed that the plastic displacement of the tank increases with the increase in the tank height and the decrease in the stiffness of tank staging. Therefore, the total displacement, which is the sum of elastic and plastic displacements, increases.

(iv). Hydrodynamic Pressure

Figure 18 shows the variation of hydrodynamic pressure versus the percentage of filling and periods for the three elevated water tanks. The means of the maximum time history of hydrodynamic pressure are presented as well.

The variations of hydrodynamic pressure the percentage of filling showed that the maximum of hydrodynamic pressure is happened for the full filling case. This pattern of variations is the same for all the three tanks. Variation of hydrodynamic pressure versus the natural period for the systems with half-full and full filling is shown in Fig. 18-b. As the period increases, the hydrodynamic pressure decreases for all the cases. Hydrodynamic pressure of the tanks No. 2 and No. 3 is compared with that of the tank No. 1 in Fig. 18-a. and the results indicated a 9% and 8% increase in the hydrodynamic pressure of the half-full and full tanks, respectively in the tank No. 2. Also these increases correspond with the values of 13% and 6% for the half-full and full filling cases, respectively in the tank No. 3.

Simultaneous effects of mass increase and stiffness decrease of tank staging lead to increase in the hydrodynamic pressure of vessel. The

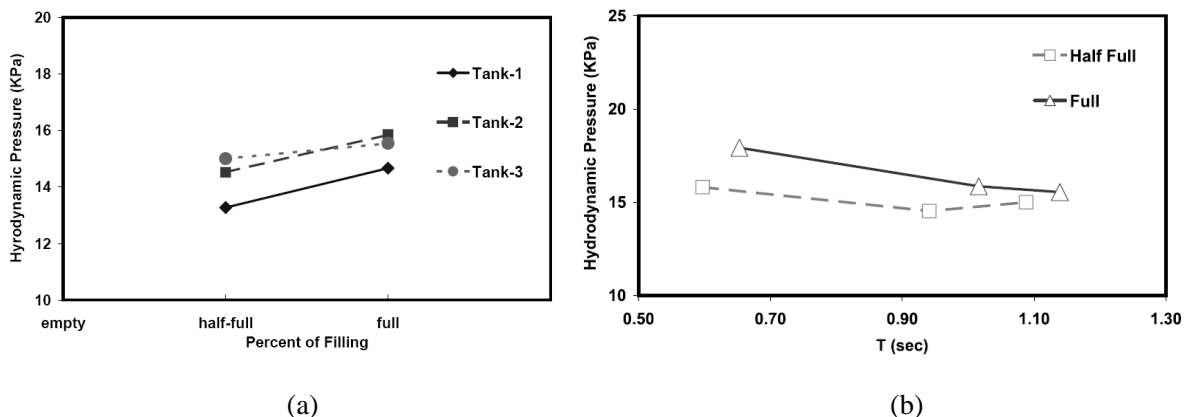

Fig. 18. Variations comparison of hydrodynamic pressure in the tanks No. 1, 2 and 3 based on: a) fullness percent; and b) Period.

evaluation of convective and impulsive pressures revealed that the records with low predominant frequency causes excitation in the convective modes with relatively high period and consequently results in high hydrodynamic pressure at fluid free surface. Excitation in the impulsive modes causes increase in the hydrodynamic pressure at low levels and also at the bottom of the tank for the records with higher predominant frequency. In this study, the maximum hydrodynamic pressure, which often occurs at the bottom, was examined. The obtained results indicated that predominant frequency of the records causes more excitation in the impulsive modes with the decrease in the system's frequency. Consequently hydrodynamic pressure of the vessel increases with the decrease in the stiffness of tank staging.

10. Conclusion

In this work, three elevated water tanks supported by moment resisting frame were considered and subjected to seven pairs of selected earthquake records. The seismic demands of the elevated water tanks were determined using the nonlinear time history analysis for the empty, half-full and full filling cases. The following conclusions are drawn from the results of this study:

1. The maximum response does not always occur in the full tanks. This result may be due to the fact that the hydrodynamic pressures of container in half-full case as compared with the full filling case are higher. In addition, it can be also assigned to the effect of the frequency content of earthquake records.
2. The system predominant frequencies are located on the range of high amplitude of the frequency content of some of the selected earthquake records and causes amplification of the responses. However, in some other earthquake records, this phenomenon is not visible as the system predominant frequencies are located on the low amplitude range of frequency content.
3. The elevated tanks period showed that simultaneous effects of mass increase and

stiffness decrease of tank staging lead to increase in the natural period. A 47% decrease in the stiffness and the 25%, 17% and 13% increase in the mass of the empty, half-full and full filling tanks respectively resulted in 58%, 58% and 56% increase in the natural period of the empty, half-full and full filling tanks respectively. Also, a 56% decrease in the stiffness and the 47%, 33% and 25% increase in the mass of the empty, half-full and full filling tanks, respectively resulted in 79%, 82% and 74% increase in the natural period of the empty, half-full and full filling tanks respectively.

4. Scattering of the mean plus and minus standard deviation covers approximately 60 to 70 percents of the responses.
5. The increase in the percentage of container filling shows that that the value of base shear force, overturning moment, displacement and hydrodynamic pressure increase in the range of mean plus and minus standard deviations.
6. Comparison between the mean of the maximum responses of the tank No. 2 compared to the tank No. 1 revealed that the increase in the values of base shear force, overturning moment, displacement and hydrodynamic pressure were about 10% to 20 %, 13% to 32 %, 10% to 15 % and 8% to 9 %, respectively. Also, the increase of above-mentioned parameters in the tank No. 3 as compared to the tank No. 1 was about 14% to 33 %, 54% to 74 %, 25% to 42 % and 6% to 13 %, respectively.
7. Evaluation of the convective pressure revealed that the earthquake records with low predominant frequency cause excitation in the oscillating modes with relatively high period and consequently result in high hydrodynamic pressure at fluid free surface. Excitation in the impulsive modes causes increase in hydrodynamic pressure at low levels and at the bottom of the tank for the records with higher predominant frequency.
8. Examination of maximum hydrodynamic pressure resulting from the convective and impulsive modes showed that the

maximum pressure occurred at the lower levels of fluid free surface. Since impulsive pressure is dominant in these levels, maximum pressure occurs at the bottom of full tank.

References

- [1] Steinbrugge, K.V., Rodrigo, F.A.:1963, The Chilean earthquakes of May 1960: a structural engineering viewpoint, *Bulletin Seismology American* 53, 225–307.
- [2] Minowa, C.:1980, Dynamic analysis for rectangular water tanks, *Recent Adv. Lifeline Earthquake Engineering Japan*, 135–42.
- [3] Knoy, C.E.: 1995, Performance of elevated tanks during recent California seismic events, *AWWA Annual Conference & Exhibition*.
- [4] Attari, N.K.A., Rofooei, F.R.: 2008, On lateral response of structures containing a cylindrical liquid tank under the effect of fluid/structure resonances, *Journal of Sound and Vibration*, 318, 1154–1179.
- [5] Damatty, A.A., Saafan, El, M.S., Sweedan, A.M.I.: 2005, Experimental study conducted on a liquid-filled combined conical tank model, *Thin-Walled Structures*, 43, 1398–1417.
- [6] Sezen, H., Livaoglu, R., Dogangun, A.: 2008, Dynamic analysis and seismic performance evaluation of above-ground liquid-containing tanks, *Engineering Structures*, 20, 749–803.
- [7] Livaoglu, R., Dogangun, A.: 2006, Simplified seismic analysis procedures for elevated tanks considering fluid-structure-soil interaction, *Journal of Fluids Structure*, 22, 421–39.
- [8] Livaoglu, R.: 2005, Investigation of the earthquake behavior of elevated tanks considering fluid–structure–soil interactions, Ph.D. Thesis, Karadeniz Technical University, Trabzon, (in Turkish).
- [9] Livaoglu, R., Dogangun, A.: 2007, Effect of foundation embedment on seismic behavior of elevated tanks considering fluid–structure-soil interaction, *Soil Dynamics and Earthquake Engineering*, 27, 855–863.
- [10] Koh, H.M., Kim, J.K., Park, J.H.: 1998, Fluid–structure interaction analysis of 3-D rectangular tanks by a variationally coupled BEM-FEM and comparison with test results, *Earthquake Engineering Structure Dynamic*, 27, 109–124.
- [11] Anghileri, M., Castelletti, L.M.L., Tireli, M.: 2005, Fluid–structure interaction of water filled tanks during the impact with the ground, *International Journal Impact Engineering* 31, 235–54.
- [12] Shahverdiani, K., Rahai, A.R., Khoshnoudian, F. : 2008, Fluid-structure interaction in concrete cylindrical tanks under harmonic excitations, *International Journal of Civil Engineerng*. 6 (2), 132-141.
- [13] Goudarzi, M.A., Sabbagh-Yazdi, S. R.: 2009, Numerical investigation on accuracy of mass spring models for cylindrical tanks under seismic excitation, *International Journal of Civil Engineerng*, 7(3), 190-202.
- [14] Housner, G.F.: 1963, Dynamic behavior of water tanks, *Bulletin Seismology Society American*, 53, 381–7.
- [15] Housner, G.W.: 1957, Dynamic pressures on accelerated fluid containers, *Bulletin Seismology Society American*, 47, 15–35.
- [16] Westergaard, H.M.:1931, Water pressures on dams during earthquakes, *Proceedings of the ASCE*, 57.
- [17] Barton, D.C., Parker, J.V.: 1987, Finite element analysis of the seismic response of anchored and unanchored liquid storage tanks, *Earthquake Engineering and Structural Dynamics*, 15, 299–322.
- [18] Dogangun, A., Durmus, A., Ayvaz, Y.: 1966a,

- Finite element analysis of seismic response of rectangular tanks using added mass and Lagrangian approach, Proceedings of the Second International Conference on Civil Engineering Computer Applications Research and Practice, Vol. I, Bahrain, April 6–8, pp. 371–379.
- [19] Haroun, M.A., Ellaithy, M.H.: 1985, Seismically induced fluid forces on elevated tanks, *Journal of Tech. Top Civil Engineering*, 111, 1-15.
- [20] Marashi, E.S., Shakib, H.: 1997, Evaluations of dynamic characteristics of elevated water tanks by ambient vibration tests, Proceedings of the 4th International Conference on Civil Engineering, Vol. I, Tehran, Iran, pp. 367–73.
- [21] Reshidat, R.M., Sunna, H.: 1986, Behavior of elevated storage tanks during earthquake, Proceeding of the 3rd US National Conference on Earthquake Engineering, pp. 2143-54.
- [22] Haroun, M.A., Termaz, M.K.: 1992, Effects of soil-structure interaction effects on seismic response of elevated tanks, *Soil Dynamics Earthquake Engineering*, 11, 37-86.
- [23] Shrimali, M.K., Jangid, R.S.: 2003, Earthquake response of isolated elevated liquid storage steel tanks, *Journal of Constructional Steel Research*, 59, 1267–1288.
- [24] Dutta, S.C., Jain, S.K., Murty, C.V.R.: 2001, Inelastic seismic torsional behavior of elevated tanks, *Journal of Sound and Vibration* ,242, 151–167.
- [25] Shekari, M.R., Khaji, N., Ahmadi, M.T.: 2008, A coupled BE-FE study for evaluation of seismically isolated cylindrically liquid storage tanks considering fluid–structure interaction, *Journal of Fluids and Structures*: doi: 10.1016/j.jfluidstructs.2008.07.005.
- [26] Panchal, V.R., Jangid, R.S.: 2008, Variable friction pendulum system for seismic isolation of liquid storage tanks, *Nuclear Engineering and Design*, 238, 1304-1315.
- [27] Dutta, S.C., Jain, S.K., Murty, C.V.R.: 2000a, Alternate tank staging configurations with reduced torsional vulnerability, *Soil Dynamics and Earthquake Engineering*, 19, 199–215.
- [28] Dutta, S.C., Jain, S.K., Murty, C.V.R.: 2000b, Assessing the seismic torsional vulnerability of elevated tanks with RC frame-type Staging, *Soil Dynamics and Earthquake Engineering*, 19, 183–197.
- [29] Omidinasab, F., Shakib, H.: 2008, Seismic vulnerability of elevated water tanks using performance based- design, The 14th World Conference on Earthquake Engineering, Beijing, China.
- [30] Zienkiewicz, O.C., Bettles P.: 1978, Fluid-structure dynamic interaction and wave forces; an introduction to numerical treatment, *International Journal of Numerical Methods in Engineering*, 13, 1–16.
- [31] Wilson, E.L., Khalvati, M.: 1983, Finite elements for the dynamic analysis of fluid-solid systems, *International Journal of Numerical Methods in Engineering*, 19, 1657–1668.
- [32] Olson, L.G., Bathe, K.J.: 1983, A study of displacement-based fluid finite elements for calculating frequencies of fluid and fluid–structure systems, *Nuclear Engineering and Design*, 76, 137–151.
- [33] Dogangun, A., Durmus, A., AyvazY. : 1996b, Static and dynamic analysis of rectangular tanks by using the Lagrangian fluid finite element, *Computers & Structures*, 59, 547–552.
- [34] Dogangun, A., Livaoglu, R.: 2004, Hydrodynamic pressures acting on the walls of rectangular fluid containers, *Structural Engineering and Mechanics*, 17, 203–214.
- [35] Donea, J., Gyuliani, S., Halleux, J.P.: 1982, An arbitrary Lagrangian–Eulerian finite element method for transient dynamic fluid-structure

- interaction, *Computer Methods in Applied Mechanics and Engineering*, 33, 689–723.
- [36] Bauer, H.F.: 1964, Fluid oscillations in the containers of a space vehicle and their influence upon stability, NASA TR R 187.
- [37] European Committee for Standardization, Eurocode-8, and Part 4: silos, tanks and pipelines, Final PT, 2001.
- [38] Park, R., Kent, D.C., Sampton, R.A.: 1972, Reinforced concrete members with cyclic loading, *Journal of the Structural Division ASCE*, 98, 1341–60.
- [39] Scott, B.D., Park, R., Priestley, M.J.N.: 1982, Stress-strain behavior of concrete confined by overlapping hoops at low and high strain rates, *ACI*, 79, 13–27.
- [40] Kwak, H.G., Filippou, F.C.: 1990, Finite element analysis of reinforced concrete structures under monotonic loads, Report No.UCB/SEMM-90/14, Berkeley (CA), University of California.