

# Bond strength of reinforcement steel in self-compacting concrete

A. Foroughi-Asl<sup>1</sup>, S. Dilmaghani<sup>2</sup>, H. Famili<sup>3</sup>

<sup>1</sup>Civil Engineering, University of Tabriz, Iran, Aforough@Tabrizu.ac.ir

<sup>2</sup>University of Tabriz, Iran, Sdilmaghani@Tabrizu.ac.ir

<sup>3</sup>Iran University of Science & Technology, Hormoz.Famili@gmail.com

**Abstract:** *Self-Compacting Concrete (SCC) is a highly fluid yet stable concrete that can flow consistently under its own weight, pass between bars, and fill in formwork without the need of compaction. The application of SCC effectively resolves the difficulties of concreting in situations with complicated formwork and congested reinforcements. In this paper, the bond between SCC and steel reinforcement was investigated. The bonding strengths of reinforcing bars were measured using cubic specimens of SCC and of normal concrete. The SCC specimens were cast without applying compaction, whereas the specimens of normal concrete were cast by conventional practice with substantial compaction and vibration. The results showed that SCC specimens generated higher bond to reinforcing bars than normal concrete specimens and the correlation between bond strength and compressive strength of NC is more consistent.*

**Keywords:** *Self-compacting concrete; bond strength; bars; vibration; compaction.*

## Introduction

The specification of concrete workability is usually adopted to resolve the problems of concrete placement. The required workability for casting concrete depends on several factors, such as the type of construction, the selected methodology of placement and type of equipment for compaction, the shape of formwork, and degree of congestion of the reinforcement. With the increase in using congested reinforcements in moment-resisting reinforced concrete structures, there has been a growing interest in specifying high workability concrete. When the workability of concrete is increased, it may result lack of stability in the concrete mixture and weakening of the interface between aggregate and cement paste. It may also increase the tendency to develop local microcracking. Therefore, under the conventional practice of construction, high workability of concrete tends to increase the permeability and reduce mechanical properties.

The application of SCC remarkably lowers the complexity of construction by reducing the demand for a significant amount of compacting force and skillful workmanship. Therefore, SCC allows a much easier construction task and results in a more reliable quality in concrete placement and a more homogeneous material structure.

Application of SCC is expected to increase the flexural behavior and loading capacity of specimens due to the superior passing and filling capability of SCC that may directly enhance the bond between reinforcements and concrete. To evaluate the advantages of SCC quantitatively, an experimental program was conducted to measure the bond strength of reinforcing bars in SCC as well as in normal concrete.

For instance, the filling ability of concrete mixtures was evaluated by the slump flow test (two methods), the filling ability and segregation resistance by the discharge time in the V-funnel test (two methods) and self-compactibility by the passing ability in L-box test. The workability of normal concrete (NC) specimens was evaluated by using slump test [1]. The bond strength of deformed and plain bars in SCC and in NC were measured by a series of embedded bars in pull-out tests.

Several variables were examined, including age of concrete, size and shape of reinforcing bars, (w/c) ratios and type of concrete materials. In the experimental program, the SCC specimens were cast by nonvibration practice, while the normal concrete specimens (NC), were cast by conventional procedures with substantial amount of compaction. To investigation the characteristics of bond development, reinforcing

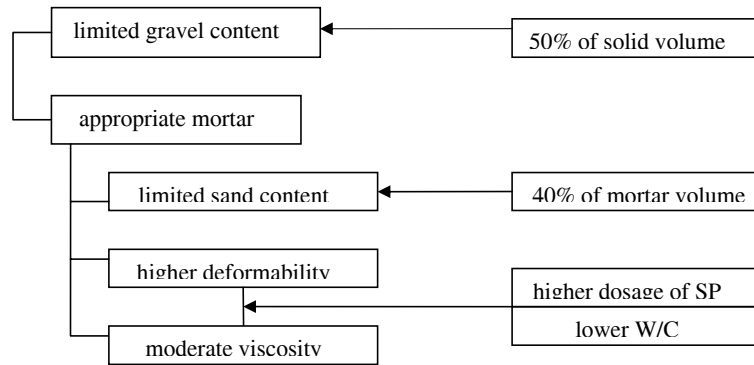

**Fig.1** H. Okamura and K. Ozawa's mix design model.

**Table 1** Chemical and physical properties of cement type II

(Chemical Properties)

Composition	Amount	
Free lime	Max	1.5%
SO <sub>3</sub>	Max	0.4%
L.O.I	Max	0.4%
MgO	Max	4.5%
C <sub>3</sub> A	Max	8.0%
Chloride	Max	0.1%
Alkali Content	Max	1.0%

(Physical Properties)

Property	Value	
$f'_c$ (3 day)	Min	12 MPa
$f'_c$ (7 day)	Min	20 MPa
$f'_c$ (28 day)	Min	34 MPa
Fineness	Min	2800 Cm <sup>2</sup> /gr
Autoclave Expansion	Min	0.80 %
Setting Time-Vicat	Min	60 minutes

bar pull-out tests were conducted at various ages of concrete, starting from the setting time of concrete to 56 days.

test of reinforcing bars embedded in SCC specimens and also in NC specimens and the results are compared.

## Research Significance

This research has special significance in construction practice and materials specification, in reinforced concrete projects. The measured bond strength of reinforcing bars can be used for the evaluation of the feasibility of using SCC. There is more relevant structural performance, but in this paper, only bond strength is investigated in view of extension of design rules from normal concrete (NC) to SCC.

## Experimental Program

The bond properties of reinforcing bars in SCC were studied by conducting direct pull-out

## Materials

ASTM-C150 Type II cement (Table 1) and silica fume meeting ASTM-C311 were used as cementitious materials.

Natural river sands (Mamaghan River, Tabriz) and crushed gravels (Fatholmabin Mine) were used as fine and coarse aggregates respectively. The characteristics of the aggregates are given in Table 2. The aggregates meet ASTM-C33 specifications.

The superplasticizer used was polycarboxylic acid-based with relative density 1.03. The mixture proportions of SCC and NC are summarized in Table 3 and 4 respectively.

**Table 2** Characteristics of materials

Properties	Unit	Amount
Gravel (G) Absorption	%	1.0
Sand (S) Absorption	%	1.6
Fineness Modulus (FM)	-	2.46
Maximum aggregate size ( $D_{max}$ )	mm	19
Aggregate Density	kg/lit	2.67
S/(G+S)	-	0.49
G/S	-	1.06

**Table 3** Mixture proportions of SCC

Material	Unit	(W/C)				
		0.30	0.40	0.45	0.50	0.60
Water	lit	0.41	0.55	0.62	0.69	0.82
Cement	kg	1.25	1.25	1.25	1.25	1.25
Silica Fume	kg	0.12	0.12	0.12	.12	0.12
Gravel	kg	3.22	3.22	3.22	3.22	3.22
Sand	kg	3.05	3.05	3.05	3.05	3.05
Superplasticizer	CC	99	73	61	52	30

**Table 4** Mixture proportions of NC

Material	Unit	(W/C)				
		0.30	0.40	0.45	0.50	0.60
Water	lit	0.41	0.55	0.62	0.69	0.82
Cement	kg	1.25	1.25	1.25	1.25	1.25
Gravel	kg	3.22	3.22	3.22	3.22	3.22
Sand	kg	3.05	3.05	3.05	3.05	3.05

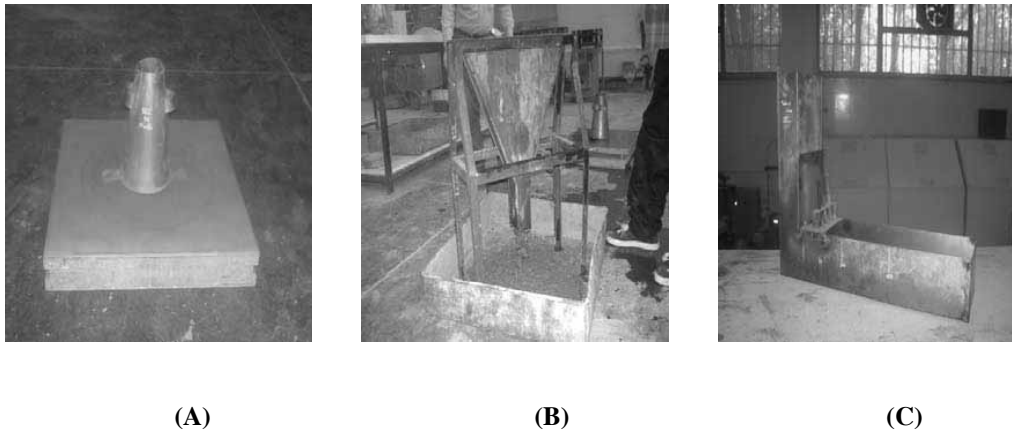

**Fig. 2** (A) slump flow test, (B) V-funnel test & (C) L-box test.

The dosage of superplasticizer was optimized by trial mixing so that the concrete mixture may possess sufficient workability and cohesiveness.

Before casting the specimens, several tests, including slump flow, slump flow ( $T_{500\text{mm}}$ ), V-funnel, V-funnel ( $T_5$ ) and L-box test, were conducted to assure that the concrete mixture was qualified as SCC (Fig. 2) [2-4].

The results are summarized in Table 5. In this table, the criteria for SCC as suggested by EFNARC [5] and Brite Eu Ram [6] are also given.

Three specimens were tested for each type of fresh SCC test methods. By considering the results, the amount of superplasticizer for different specimens were determined. Obviously the determined amounts of superplasticizer used are based to the results of all test methods.

### Casting of specimens

The SCC specimens were cast in one lift. Neither external nor internal vibration was applied. On the other hand, the normal concrete (NC) specimens were cast using conventional construction practice. Specimens were cast in 150 mm cube moulds with embedded reinforcing bars of # 10 (plain), 10, 16 and 20 (ribbed) in each specimen. The diameters of # 10, # 16 and # 20 are 10, 16 and 20 mm respectively. The

embedded length of reinforcing bars in specimens were 100 mm. to avoid an unplanned force transfer between the reinforcing bar and the concrete in the unbonded area, the rebars were encased with a plastic tube and sealed with a highly elastic silicone material. The rebars were placed concentrically and the concrete was cast parallel to the loading direction. The specimens were cured in water for 3, 7, 28 and 56 days to avoid changes in the curing conditions and 3 specimens for each concrete age.

For comparison of bond strength in plain and ribbed bars, specimens were cast in 100 mm cube moulds with embedded length of reinforcing bars equal to 50 mm.

### Pull-Out tests

One appraisal of bond test methods suggested that even the Standard RILEM pull-out test could be useful for comparative evaluation of bar performance relevant to a range of functions, with crack control performance assessed through a correlation with bond stress at a free end slip of 0.01 mm, bond strength in a splitting failure mode assessed through a correlation with bond stress at a free end slip of 0.1 mm, and pull-out strength of ribbed bars assessed through a correlation with bond stress at a free end slip of 1.0 mm. For the time being, standard bond tests must be considered of limited value, and any new reinforcing materials need to be tested for bond

**Table 5** Fresh concrete properties of SCC

Test	Unit	Sample No.	(W/C)				
			0.30	0.40	0.45	0.50	0.60
<b>Slump flow</b> (EFNARC= 650-800) (Brite Eu Ram=600-725)	mm	SCC1	698	715	719	700	720
		SCC2	700	712	714	695	718
		SCC3	708	703	726	718	704
<b>Slump flow (T<sub>500</sub>)</b> (EFNARC= 2-5 ) (Brite Eu Ram =3-7)	sec.	SCC1	3.6	2.7	1.9	2.9	3.0
		SCC2	3.8	2.5	2.3	3.4	2.9
		SCC3	3.7	3.0	1.8	3.9	2.2
<b>V-funnel</b> (EFNARC= 6-12) (Brite Eu Ram = 5-15)	sec.	SCC1	10.8	8.4	6.9	10.1	9.0
		SCC2	12.0	8.3	7.2	9.7	8.6
		SCC3	11.4	7.8	8.0	9.1	9.5
<b>V-funnel (T<sub>5</sub>)</b> (EFNARC= 6-15) (Brite Eu Ram =5-18)	sec.	SCC1	18.1	13.8	11.0	15.0	12.5
		SCC2	18.8	12.9	12.6	15.0	10.8
		SCC3	17.4	14.0	10.6	16.3	13.8
<b>L-box</b> (EFNARC= 80-100) (BriteEu Ram =60-80)	%	SCC1	61.7	78	79.4	65.0	70.0
		SCC2	61.7	72.4	83.0	62.3	71.8
		SCC3	63.0	73.0	82.8	60.0	68.2
Is there segregation of aggregates?			No.	No.	No.	No.	No.

performance in structural elements under conditions representative of practice. The bond behavior was tested with pull-out test specimens which were modified RILEM/CEB/FIP standard pull-out test and Rehm and Eligehausen pull-out test. Since the weakpoints of Rehm's test were the friction between the cubic specimen and the bearing plate, and the arch-effect in the central region (close to the bonded portion of the bar), the bonded length was moved away from the central region [7]. The tests were carried out in an electro mechanic testing machine (AMSLERS), where the specimens were loaded path-controlled. The loading rate was 150 kg/sec. The applied force of the machine was measured (Fig. 3). For the support of specimens in the machine, a 250×250×15 mm plate with a 50 mm diameter hole in its center is used.

## Results and discussion

By conducting the pull-out tests, the bond strength between concrete and reinforcements can be obtained from the pull-out load. In this research, the bond strengths obtained by pull-out test are used for comparison of variables. If the measured bond strengths are to be applied for design purposes, the characteristics of pull-out test need to be taken into consideration. In general, the bond stress corresponding to the maximum pull-out load can be regarded as the bond strength, or, to be more specific, the ultimate bond strength. The criterion of ultimate bond strength has been widely adopted by most researchers [8&9] because of its clear definition and the simplicity in bond strength interpretation. Nevertheless, there are researchers who propose

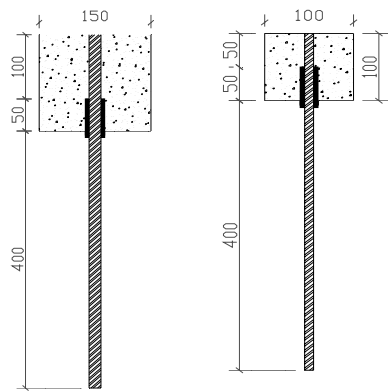

(Scale in mm)

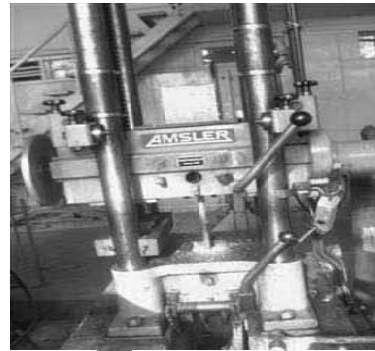

**Fig. 3** Pull-Out test specimen and loading machine

an alternative interpretation criterion called critical bond strength [7]. The critical bond strength is defined as the bond stress of a reinforcing bar corresponding to a slip distance of 0.25 mm.

It is observed that the ultimate bond strength, that is, the maximum average bond stress, would occur at a bond slip of several mm depending on the embedment length. In terms of structural behavior, this pull-out displacement would be equivalent to the crack width of a loaded member.

Obviously, a loaded member with such a large crack may have already undergone a significant deflection and can be close to the ultimate stage. Therefore, for structural analysis or design purposes, adopting the ultimate bond strength for calculating the required development length will be unconservative. In other words, the ultimate bond strength tends to overestimate the bond between reinforcement and concrete.

The concept of critical bond strength would be more meaningful from a designer's point of view. The critical bond strength, thus defined, possesses a better correlation to the development length as recommended by ACI -318 Code provisions [8]. In other words, the required development length based on the critical bond strength may assure a larger factor of safety. Henceforward, the critical bond strength will be adopted for the interpretation of the bond strength

from the pull-out test results.

In this experimental program, the pull-out tests were conducted to measure the ultimate bond strengths at various ages starting from final set of concrete. The characteristics of pull-out curves would be different for concrete at different ages.

### Development of bond strength with age

The results of pull-out tests on the bond strength development of reinforcing bars in SCC and NC are summarized in Table 6.

During the pull-out test, the pull-out load are recorded. The pull-out load is then converted into bond stress based on the embedment length and reinforcing bar perimeter

$$\tau = \frac{P}{\pi dl}$$

where  $P$ ,  $d$  and  $l$  refer to the applied load, bar diameter and embedment length, respectively.

Table 6 summarizes the development of bond strength of reinforcing bars with age in SCC and NC starting from the initial setting time. Figures 4 and 5 provide the trends of bond strength development of SCC and NC that are based on the results of Table 6. Figure 4 shows five bond strength development curves of SCC and Figure 5 shows five bond strength development curves of NC for five different values of (w/c) ratios.

**Table 6** Results of pull-out test as affected by the age of concrete

Material	SCC					NC				
	(W/C) 0.30	0.40	0.45	0.50	0.60	0.30	0.40	0.45	0.50	0.60
Age	Bond strength, MPa									
3 days	5.98	5.43	5.23	4.67	4.23	8.80	7.65	6.99	6.10	5.43
7 days	8.66	7.95	7.55	6.76	6.47	11.13	9.35	8.93	7.97	7.17
28 days	13.92	12.62	11.73	10.69	10.42	12.89	12.14	11.10	9.84	9.52
56 days	15.60	13.68	12.98	11.78	11.22	14.50	12.90	11.97	11.16	10.63

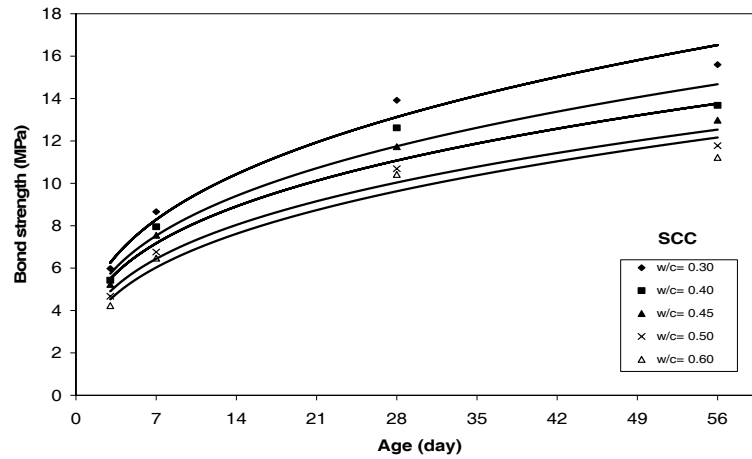

**Fig. 4** Bond strength development in SCC

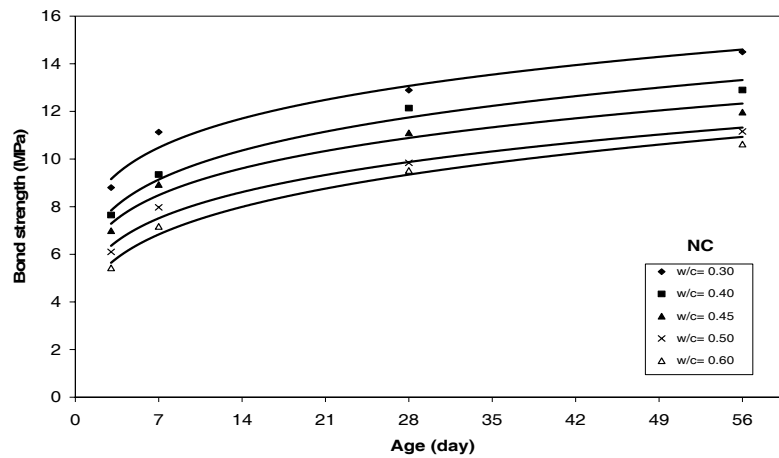

**Fig. 5** Bond strength development in NC

### Influence of compressive strength

The compressive tests were also conducted at the corresponding age of each reinforcing bar pull-out test. Specimens were cast in 150 mm cubic moulds. The development of compressive strength of SCC and NC are summarized in Table 7 and is given in Fig. 8. Fig. 6 shows (as a simple) that at the ages of 3 and 7 days, the compressive strengths of NC specimens are higher than SCC

specimens, while at the ages of 28 and 56 days, the compressive strengths of NC specimens are lower than SCC specimens. An intersection point is happened around the ages of 21-23 days. Because silica fume and superplasticizer (SP) are used in the SCC mixture proportions.

The slow development of compressive strength and bond strength in SCC at early age is generally due to the retarding effect of the

**Table 7** Results of compressive strength of SCC and NC specimens

Material	SCC					NC				
(W/C)	0.30	0.40	0.45	0.50	0.60	0.30	0.40	0.45	0.50	0.60
Age	Compressive strength, MPa									
3 days	24.16	21.14	19.21	17.95	17.05	34.55	29.47	26.14	23.86	22.04
7 days	38.64	34.09	30.61	28.03	26.14	49.09	40.91	36.52	32.88	29.09
28 days	61.59	52.05	47.42	42.50	40.00	58.41	49.54	45.23	41.02	38.56
56 days	72.73	65.07	61.51	58.20	55.00	66.36	59.77	56.59	55.00	52.27

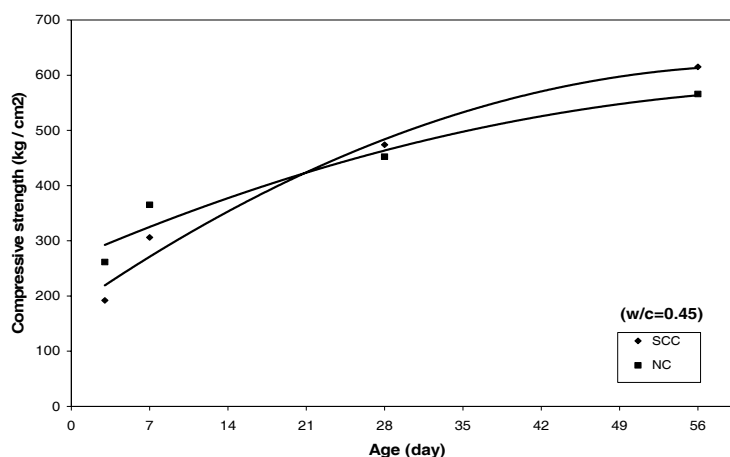

**Fig. 6** Development of compressive strength of SCC and NC.

**Table 8** Comparison of Bond Ratio of SCC and NC by  $\tau/f_c'^{1/2}$

Material	SCC					NC				
(W/C)	0.30	0.40	0.45	0.50	0.60	0.30	0.40	0.45	0.50	0.60
Age	$\tau/f_c'^{1/2}$									
3 days	1.22	1.18	1.19	1.10	1.02	1.50	1.41	1.37	1.25	1.16
7 days	1.39	1.36	1.35	1.28	1.26	1.59	1.46	1.48	1.39	1.35
28 days	1.77	1.75	1.70	1.64	1.65	1.69	1.72	1.65	1.54	1.53
56 days	1.83	1.70	1.66	1.54	1.51	1.78	1.67	1.59	1.50	1.47

carboxylic-based superplasticizer used.

To compare the bond strength of SCC and NC, the compressive strength has to be taken into account.

According to the provisions of ACI 318 [8], the development length of reinforcing bar for sufficient anchorage is inversely proportioned to the square root of the compressive strength, implying that the bond strength should be linearly proportional to square root of compressive strength.

The bond strength is then normalized dividing by  $\sqrt{f_c'}$ . The normalized bond strengths of SCC and

NC are given in Fig. 7 and 8. Table 8 and Fig. 7 and 8 give the comparison of bond strength of SCC and NC after the influence of compressive strength is taken into account.

Figure 7 and 8 provide the trends of development in unit bond strength  $\tau/\sqrt{f_c'}$  with age.

If the correlation between  $\tau$  and  $f_c'$  is valid at various age, plots of versus age should be a horizontal line. From this the point of view, the correlation between  $\tau$  and  $f_c'$  of NC is more consistent according to Fig. 7 & 8.

Yin-Wen Chan et al [10] reported a similar



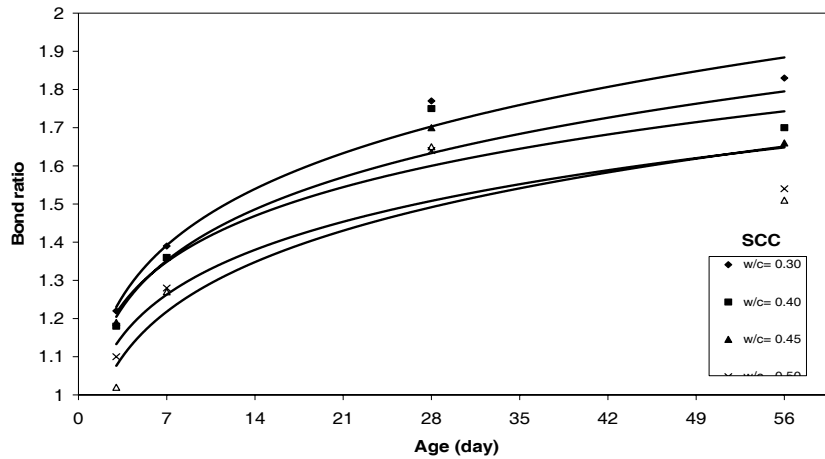

Fig. 7 Age effect on bond strength ratio  $\tau/f_c'$  <sup>1/2</sup> of SCC

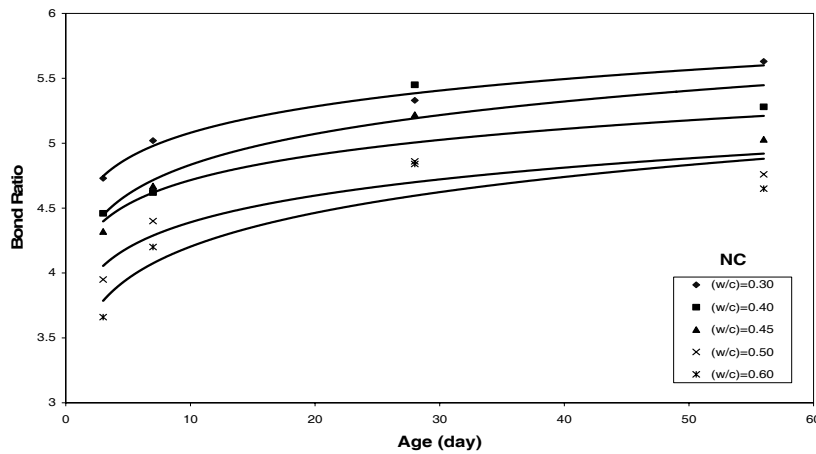

Fig. 8 Age effect on bond strength ratio  $\tau/f_c'$  <sup>1/2</sup> of NC

finding in full-scale reinforced concrete members of SCC and of NC.

### Conclusions

Based on this study, the following conclusions can be made:

- At early ages, because of retarding effect of superplasticizing admixtures in the SCC mix, the development of compressive and bond strength of SCC is slow. Therefore in the case of SCC more attention needs to be paid to the consideration of construction safety.
- In case of SCC, increasing the dosage of superplasticizer decreases the amount of required water in the mix, but the test results showed that this relationship is not linear.

- In the present work, the SCC specimens were cast in one lift without any vibration. Maximum bond strength determined by the ultimate bond strength criteria was measured to be 13.92 MPa (at 28 days) and 15.60 MPa (at 56 days). This variations is less significant than the case of normal concrete.

- The relationship between bond strength and compressive strength of normal concrete is more consistent than SCC.

- Because of the improvement of bond strength in SCC, using this type of concrete instead of normal concrete in construction, produces significant advantages.,

- Using carboxylic acid-based type of superplasticizer in SCC, produces more uniform

concrete without any segregation.

## References

- [1] Mullick, A.K., High performance concrete for bridges and highways pavements, *Advances in bridge engineering*, 24-25, 2006, pp.51-63.
- [2] Bartos, P.J.M. and Grauers, M., Self-compacting concrete, *Concrete*, Vol. 33(4), 1999, pp. 9-14.
- [3] Billberg, P., Self-compacting concrete for civil engineering structures, The Swedish experience, Swedish Cement and Concrete Research Institute. Sweden, 1999.
- [4] Brite Eu Ram, Guidelines for SCC, Task 2, Workability, No. BE96-3801, Sweden 1999.
- [5] EFNARC, The European Guidelines for Self-Compacting Concrete (SCC),UK, 2002, 2005.
- [6] Brite Eu Ram, Guidelines for SCC, Task 9, End Product, No. BE96-3801, Sweden, 2000.
- [7] Fib, Bulltin 10, Bond of reinforcement in concrete, state of the art Report prepared by Task Group Bond Models, former CEB, Task Group 5.2.CH-1015, Lausanne, August 2000.
- [8] ACI Committee 318, Building Code Requirements for Structural Concrete (ACI 318- 02) and commentary (318R-02), USA, 2002.
- [9] Tayfun A. Söylev and Raol François, Effects of bar-placement conditions on steel concrete, *Materials and structures*, Vol. 39 (2), 2006, pp.187-195.
- [10] Yin-Wen Chan, Yu-Sheng Chen, and Yi-Shi liu, Development of bond strength of reinforcement steel in self-compacting concrete, *ACI Structural Journal*, July-August, 2003, pp.490-498.