

Effect of Easy-Going Steel Concept on the Behavior of Diagonal Eccentrically Braced Frames

H. Bahrampoor¹ and S. Sabouri-Ghomi^{2,*}

Received: December 2009

Accepted: March 2010

Abstract: From the time that civil engineers have used steel in building structures, they tried to increase its strength so as to produce more economic and lighter structures by using more elegant sections. Increase of steel strength is not always useful for all members of a steel structure. In some members under certain conditions, it is needed to reduce the strength as much as possible to improve the behavior of structure. By using very low strength steel according to the Easy-Going Steel (EGS) concept in this research, it is shown that the performance of diagonal Eccentrically Braced Frames (EBFs) improves substantially. For this purpose, a finite element analysis was used to simulate diagonal eccentrically braced frames. Fifteen diagonal eccentrically braced frames were designed through AISC2005. By substituting very low strength steel instead of carbon steel with equal strength in the links, their performance improve fundamentally without any global or local instability in their links.

Keywords: Eccentrically Braced frames, Link, Easy-Going steel, Hysteresis behavior

1. Introduction

Structures located in seismic regions must be designed to resist internal forces caused by earthquake induced support excitations. Due to uncertainty involved in determining seismically induces inertial forces, the structural engineer must rely on satisfying the basic requirement of earthquake resistant design. Generally, structural damage is avoided by providing the structure with enough strength to remain elastic throughout the minor earthquakes. Sufficient elastic stiffness must be provided to prevent excessive deflection and thereby preclude the occurrence on non-structural damage. During a moderate event, the structures should not undergo any structural damage. But, a limited amount of nonstructural damage is allowed. In this situation, the structure can undergo minor inelastic activity and the resulting deflection can become large enough to cause some non-structural damage. The requirement of earthquake resist design is that the structure should not collapse during this event. The underlying motivation for this requirement is to

prevent structural collapse and minimize the possibility for loss of life. To meet this requirement, the structure must be able to dissipate large amount of energy through inelastic deflections.

By proper application of these requirements, structural steel has been used for many applications because of its strength and ductility. For many years, structural engineers have utilized two types of structural steel framing for these applications: moment resisting frames (MRF) and concentrically braced frames (CBF).

For high and medium rise building, structural steel has been used moment resisting frames extensively due to their excellent strength and ductility properties. During a major earthquake, in an MRF the energy dissipation is mainly obtain through inelastic action in the beam column joints, and such frames generally have considerable ductility if the beams and columns are proportioned to meet the so-called strong column-weak beam design concept and proper details are implemented in the beam-column joints. Tests on moment resisting beam-column subassemblies demonstrated the stable non-deteriorating hysteretic loops desirable for energy dissipation purposes [1].

Moment resisting frames also have disadvantages. Although the column flexure is not of significant magnitude, an MRF tends to be laterally flexure in the elastic range, due to the

* Corresponding author. Email: Sabouri@kntu.ac.ir

1

2 Associate Professor, K. N. Toosi University, Iran.

large flexural deformation of the beams [2]. Therefore limiting the elastic interstory drift often governs the seismic design of the frame. The commonly used solution for this problem is to increase the beam size, which makes this type of frame more costly. Second, the large beam end moments inherent with this system often result in substantial shearing deformations in the column panel zones. These panel deformations can contribute significant amounts to the story drift, resulting in increased P- Δ effects. Pauley [3] has shown that moment resisting frames during some instants of large earthquake motion behave very differently from what is assumed in static analysis.

The second widely used framing system is the concentrically braced frames which utilize a set of diagonal braces placed at the joints and the braces provide effective resistance against lateral loading during minor earthquake.

The intrinsic stiffness of braced frames often makes them economically advantageous for the shorter plan dimension. Architecturally, such frames are less desirable than moment resisting frames because of the obstructions produced by the braces. Caution should be exercised in adopting such a system because repeated buckling of the diagonal braces causes a rapid decrease in the brace capacity [4]. However, when overloading occurs due to a major earthquake, conventionally designed braces can buckle exhibiting the plastic mechanism. This causes hysteretic pinched loops for such systems during inelastic load reversals [5]. The severity of the pinching depends on the slenderness ratio of the brace.

The two basic requirements for seismic design, high stiffness at working load levels and large ductility at rare but severe overloads, are difficult to satisfy when the above conventional frames are used. A hybrid system which can satisfy both the elastic stiffness and energy dissipation criteria has been gaining acceptance. This system is the eccentrically braced frame (EBF).

In eccentrically braced frames, the axial forces in the diagonal braces are transferred to columns or to other braces by bending and shear in a portion of the beam called the link. Offsetting the braces in this fashion the maximum force that can

be imparted to the brace depends on the shear capacity of the beam. With this limitation on brace forces, the braces can be designed to avoid the deleterious effects of cyclic buckling. The active links provide the primary energy dissipation mechanism for the system. The length of these links determines the dominant mode of inelastic behavior. Shorter links generally dissipate energy through inelastic web shear strains, while longer links dissipate energy in a manner similar to moment resisting frames, through inelastic flange normal strains. The elastic stiffness of the system approaches that of the concentrically braced frames for low to moderate eccentricities. Properly designed eccentrically Braced frames can meet the elastic stiffness and ultimate ductility requirements of earthquake resistant design.

As early as 1930 the eccentric bracing system was proposed as a method to resist wind loads [6]. The interest in this system for seismic applications has developed in recent decades. Early Japanese research demonstrated that eccentrically braced K frames, which can dissipate large amounts of energy without excessive lateral deflection [7]. The use of the link in spread k-braces was studied by Fujimoto [8]. The initial research of Roeder and Popov [9] demonstrated the excellent stiffness and dissipate capacities of systems braced. This research also showed that the excellent cyclic shear yielding properties of short links require proper restraint to control web buckling. Further, this investigation presented the first set of recommendations for the overall design of an eccentrically braced frame. An EBF must be designed for factored loads using plastic methods of analysis, and then be checked for code compliance (elastic behavior) at working loads. Only in this manner can proper functioning of the frame for dissipating energy through ductile behavior of links be assured, and global column buckling prevented [10][11]. Manheim extended the work of Roeder and Popov to the split K eccentrically braced system [11]. Web shear buckling can be substantially delayed by stiffening the web of link, and much of EBF research has been directed towards developing stiffer spacing criteria for short links [12]. Based on earlier work on short links by

Hjelmstad and Popov [13] and Malley and Popov [14], it was observed that stiffeners on only one side of the web are adequate for links of moderate depth. It was also observed that partial depth stiffeners, welded to the web but not to the flange are nearly as effective as full depth stiffeners. Since longer, flexural yielding links can offer important architectural advantages, Engelhardt and Popov studied on the behavior of long, flexural yielding links in EBFs [15].

Inelastic rotation of links is dependent on loading history. Richards and Uang develop a rotational loading protocol for short links from time-history analyses. The experimental tests performed in a parallel study show that rotation capacities in the AISC 2002 seismic provisions are satisfactory [16]. Okazaki et al studied cyclic performance of links in eccentrically braced frames to reevaluate flange slenderness limits and overstrength factors for links. The data from their program shows that flange slenderness limit for shear yielding links ($e \leq 1.6 M_p/V_p$) can be relaxed from $0.3(E/F_y)^{0.5}$ to $0.38(E/F_y)^{0.5}$ that E is modulus of elasticity and F_y is yield stress of the link. M_p is fully plastic moment and V_p is fully plastic shear capacity. They concluded that for longer links ($e > 1.6 M_p/V_p$) the experimental evidence on flange slenderness effects is not as clear, and further investigation is needed before modifications to the flange slenderness limit can be recommended [17].

New tests of prevailing A992 rolled shapes revealed that shear links designed according to current seismic provisions can fail by ductile fracture in the link web which was not observed in earlier tests. Chao et al. find that higher k-area strength in the new shapes shields this zone from high ductile fracture demands, but in doing so, the web steel is itself subjected to high plastic strains coupled with high stress triaxiality which combine to promote ductile fracture initiations at the weld ends. Prior to the 1990s, structural shapes were mostly straightened by gag method. But majority of structural shapes are now straightened through rotary-straightening process. This process is applied continuously along the length of a wide flange shape, and causes large deformations in the k-area leading to substantial work hardening that is manifested in

the form of increased strength and reduced toughness in the k-area. On the other hand, the gag method involves straightening loads that are applied at discrete points. So, the k-area yield strength of older steel shapes is likely close to that of the link web, which implies that yielding could penetrate farther into the k-area during link shear deformation which, as previously discussed, reduces demands at the weld-web interface and reduces the potential for ductile fracture in the link web [18].

In this paper Easy-Going Steel (EGS) concept was applied to diagonal eccentrically braced frames to improve their behavior. For this purpose finite element analysis of the 2/3 scale EBF which was tested by Engelhardt and Popov [15] was modeled in ABAQUS program and experimental and analytical results were compared to calibrate the software.

Then fifteen diagonal eccentrically braced frames have designed through AISC 2005 seismic provisions with traditional carbon steel and by using EGS instead of prototype material in the links. Their behavior improvement in elastic stiffness and local and global stability was studied. Since EGS is used in very small parts of the structures like active links, it does not affect the total cost of the structures too much.

2. Introduction of Easy-Going Steel Concept [19]

According to the Easy-Going Steel concept, where ever in a structural element like active link in EBF, brace in braced frame, steel plate in steel shear wall, and etc that is desirable to absorb energy by nonlinearity, lower steel strength could be used. This lower steel strength is called Easy-Going Steel (EGS). It is strongly recommended to take advantage of lowest strength steel for this purpose. In fact the benefit of using very low strength steel in comparison with carbon steel is summarized in three following points:

- 1- Modulus of elasticity is equal in both steels
- 2- The system with low strength steel yields in less shear displacement in comparison with the same system with carbon steel whereas both systems have equal strength (Fig. 1).
- 3- Ductility of low strength steel is much greater than carbon steel (Fig. 2)

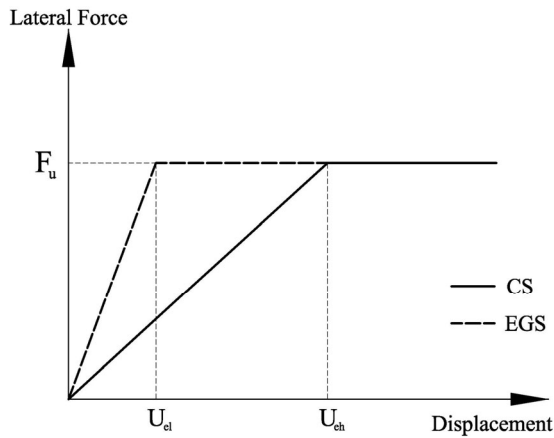

Fig. 1. Load-shear displacement diagram of various load resisting steel frames with easy-going steel and carbon steel

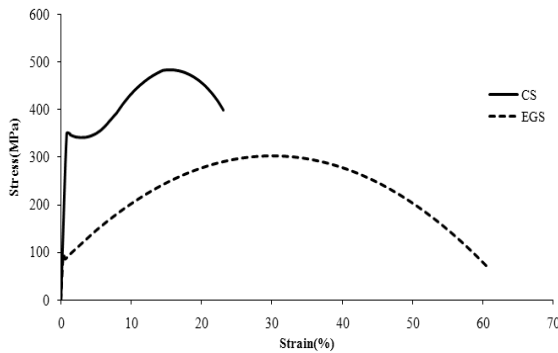

Fig. 2. Stress-strain curve of carbon steel (CS) and Easy-Going Steel (EGS)

In this paper, for improving ductility and energy dissipation capacity of diagonal eccentrically braced frames, the steel with nominal yield stress of 90 MPa is used as EGS for this component. The percentage of carbon and other alloys in this kind of steel is low and it has very high ductility. The stress-strain of both carbon steel (CS) and nominated EGS is shown in Fig. 2

2.1. Improvement Overall and Local Stability of Link by Using EGS

Stability in lateral load resisting systems is one of the most sensitive and effective parameter. Any instability in these systems can lead to overall or partial failure of the structure.

Instability in link in EBF which is commonly occurred in the form of buckling of web plate has undesirable effects on the behavior and energy dissipation of the structure.

When we use EGS ($\sigma_y=90$ MPa) instead of carbon steel ($\sigma_y=250$ MPa) in link, by increasing the shear stiffness, shear displacement decrease considerably. To achieve equal load bearing capacity in a steel shear panel link where EGS has been used, the steel plate thickness should be 2.8 times thicker ($250/90=2.8$). The effect of this thickness increment on the critical stress corresponding to the buckling limit of the steel plate (τ_{cr}), based on the plate buckling equation with hinge connection and under pure shear Eq.(1), would appear to be powered by two. It means that this stress is approximately 7.84 times higher, which is a high amount.

$$\tau_{cr} = \frac{K \pi^2 E}{12(1-\nu^2)} \left(\frac{t}{b}\right)^2 \leq \frac{\sigma_0}{\sqrt{3}} \quad (1)$$

$$K = 5.35 + 4 \left(\frac{b}{d}\right)^2 \quad \text{For } \frac{d}{b} \geq 1$$

$$K = 5.35 \left(\frac{b}{d}\right)^2 + 4 \quad \text{For } \frac{d}{b} \leq 1$$

In these equations, t is steel plate thickness, ν is poisson's ratio, b and d are the dimensions of each steel plate in shear link sub panels respectively, and σ_0 is the yield stress of steel plate.

Also, the critical shear load corresponding to the buckling limit of the steel plate (F_{wcr}) is computed from Eq. 2.

$$F_{wcr} = b \cdot t \cdot \tau_{cr} \quad (2)$$

By using EGS instead of carbon steel in the steel shear panel, with increase of the steel plate thickness by 2.8 and increase of the critical stress (τ_{cr}) by 7.8, the critical load buckling of plate (F_{wcr}) raise to: $(7.8) \times (2.8) = 21.8$

The above amount is very large and has a great effect on the improvement of the behavior of shear link in cyclic loads and shows itself in the hysteretic loops.

3. The Eccentrically Braced Frame Tested By Engelhardt and Popov (1989)

An experimental investigation on the behavior

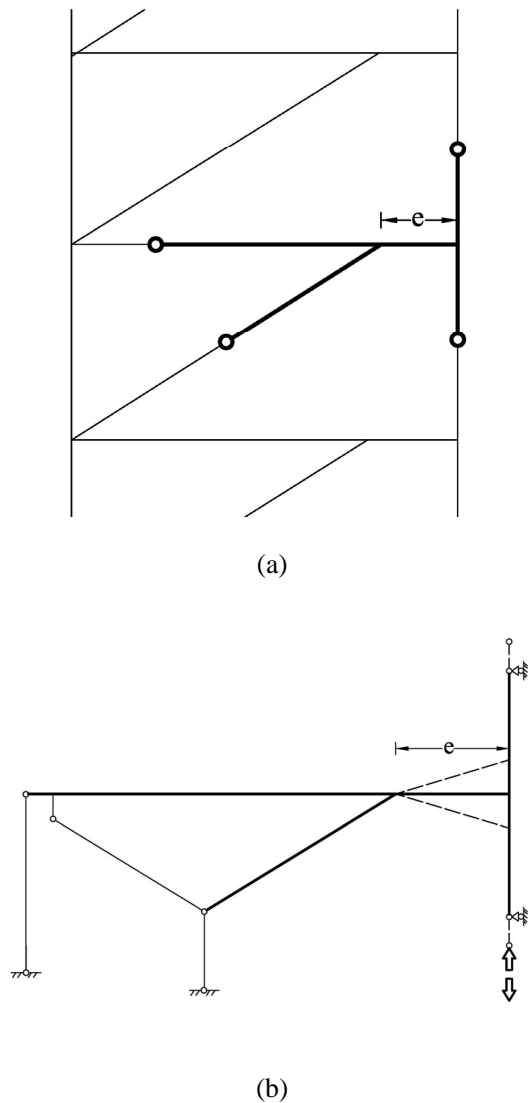

Fig. 3. (a) Prototype EBF and Location of Subassemblage
(b) Test setup for eccentrically Braced Frames tested by Engelhardt and Popov (1989)

of long, flexural yielding links in seismic-resistant eccentrically braced frames was done by Engelhardt and Popov (1989). Architectural and functional constraints calling for large openings in

braced bays are primary incentive for long links in EBFs. Because of the need for long links in mention applications, combined with the lack of experimental data in this length range, they conducted an experimental investigation. The subassemblage chosen for this experimental program models is a portion of a single diagonal EBF that is shown in Fig. 3a. The location of the subassemblage within the frame is illustrated by the bold lines. Boundaries coincide approximately with points of inflection in the prototype frame. Fig. 3b shows a schematic representation of the testing arrangement. The dimensions of the subassemblage modeled full-size frames at approximately 2/3 scale. The length of the column segments in the subassemblage are based on a nominal 3657.6 mm. The actual location of points of inflection in columns varies during an earthquake [15]. This is an important issue for column design, but should have little effect on link behavior. As indicated by Fig. 3b, the brace and the beam are essentially held in place, while the column segment is cycled back and forth. Each specimen was bolted into the test setup through end plate connections at the brace, beam, and column.

The brace segment in the subassemblage corresponds to one-half of the brace in the prototype, with an assumed point of inflection at mid-length. This was a necessary constraint in order to make use of existing test facilities and equipment. In the prototype, brace inflection points are typically located at about 0.6 to 0.8 times the length of the brace from the link. Thus, in order to maintain approximately the correct relative flexural stiffness between the beam and the brace, the point of inflection in the beam was also moved closer to the link[15]. This was accomplished in the subassemblage by introducing a small eccentricity at the beam end connection. Table 1 lists the key dimensions, the

Table 1. Test specimen property

Beam	Brace	Column	Link	Beam	Column	Brace-Beam
Section	Section	Section	length(mm)	Length(mm)	Length(mm)	Angle(deg.)
W12×16	W8×12	W10×77	711.2	3120	2438	48.2°

Table 2. Measured section dimensions

Section	d_b (mm)	b_f (mm)	t_w (mm)	t_f (mm)
W12×16	302	101.6	5.51	6.81
W8×21	211.58	134.11	6.68	9.7
W10×77	269.2	258.8	13.46	22.1

beam, brace and column sections for the specimen.

The stiffness of the column section has an important effect on the initial distribution of elastic bending moments in the link. Very stiff columns result in much higher elastic moments at the column end of the link relative to the brace end of the link. Experiments by Kasai and Popov[20] demonstrated that initially unequal end moments have little effect on the ultimate strength and rotation capacity of a short link. Both the flanges and web of the link must be welded to the column. Table 2 shows measured section dimensions of the specimen that Engelhardt and Popov had done experimental test on it.

One of stiffeners with 9.525 mm thickness was placed at about 101.6 mm from each end. This spacing is equal to one flange width and was chosen to delay the onset of flange buckling at the link ends. Locating stiffeners at b_f from the link ends is motivated by Lay's theory of flange buckling [21]. No additional stiffeners were provided within the link in an attempt to determine if web stiffening is needed in the intermediate link range. A partial depth stiffener was also provided at mid-length of the brace connection panel (Fig. 4). This stiffener was intended to delay the very severe flange and web buckling observed in the brace connection panel. A partial depth stiffener was used since all of the

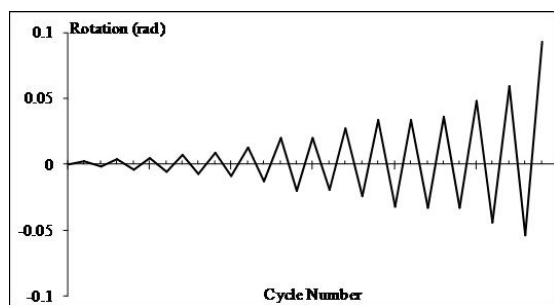
**Fig. 4.** Link rotation history

damage was concentrate in the upper portion of the panel. The stiffener extended about three-quarters of the beam depth in order to anchor the stiffener in the stable lower portion of the brace connection panel[15].

The specimen was tested pseudo-statically with slowly applied (i.e. no strain-rate effects) cyclic loads. The history of link rotation for the test specimen is shown in Fig. 4 Testing was controlled by monitoring a plot of load applied to the column versus column displacement. Load on the column is equal in magnitude to the shear force in the link. For a typical test, the specimen was first subjected to several cycles of increasing load in the elastic range. After significant yielding of the specimen was observed, displacements were progressively increased[15].

The response of the Specimen is shown in Fig. 5 Slight yielding was observed during cycle 2E and 2W in link flanges at the south end of the link and in the east flange of the brace connection panel opposite the partial depth stiffener. During cycle 4E, significant yielding was noted in the flange at the southwest end of the link, with slight additional yielding in the southeast end of the link and in the east flange of the brace connection panel. The initiation of yielding in the flange at the north end of the link was also observed during this cycle. In cycle 5, the formation of slight yield lines was observed in the beam's east flange. These yield lines were consistently oriented at about 45 degree to the longitudinal axis of the beam. During cycles 6E, web yielding became apparent in the link end panels and also towards the south end of the link's central panel, in cycles

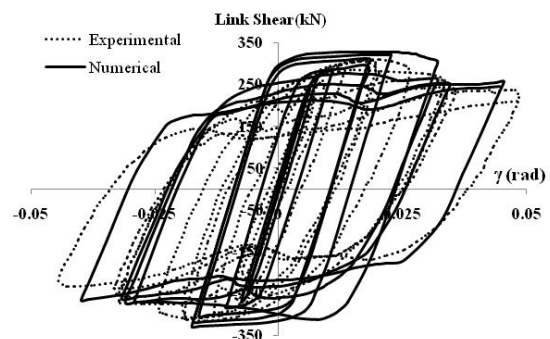
**Fig. 5.** Comparison of experimental and analytical link shear versus link rotation

7E and 7W, significant web yielding was apparent over the full length of the link. Within the central panel of the link, the web yield lines were consistently oriented parallel to the longitudinal axis of the link. Near the end of cycle 9E a large web buckle formed in the central panel of the link, running diagonally across the panel. Coincident with the formation of this web buckles was a significant drop in the link load carrying capacity. With each successive loading cycle, the buckle in the central link panel becomes more severe. Whenever the direction of loading was reversed the location of the web buckle also switched between opposite diagonal comers the panel. During final cycle a tear developed the central portion of the link, web. This tear continued to grow rapidly, and the test was terminated[15].

The hysteretic behavior of Specimen is typical of many previous tests on short links subject to cyclic inelastic web-buckling [13]. Each cycle displays a peak load followed by a drop in

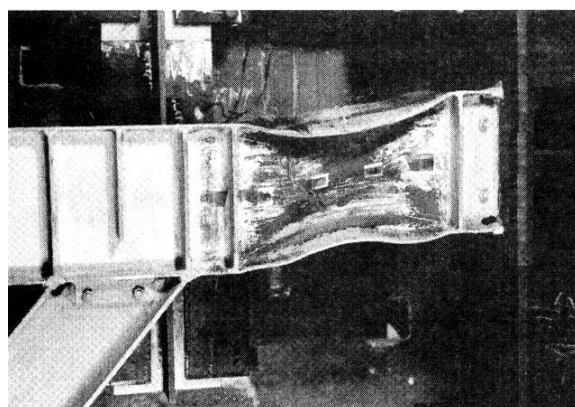

(a)

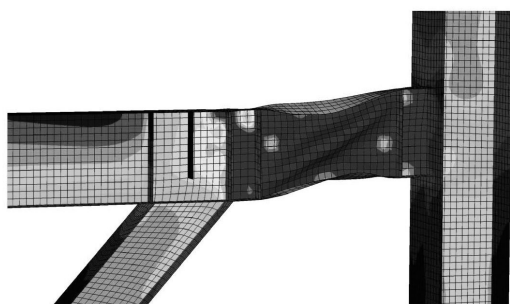

(b)

Fig. 6. Specimen after testing (a) Engelhardt and Popov (1989) (b) finite element analysis results

capacity due to formation of the web buckle. Upon continued loading, capacity once again increases due to the formation of a tension field. Associated with formation of the tension field is the development of flange distortions in the buckled panel (Fig. 6-a). Load carrying capacity degrades steadily with each cycle until tearing of the web finally occurs.

4. Finite Element Modeling

A finite element model of the frame from the proof-of-concept test was developed in ABAQUS [22]. Shell elements were used to represent the webs, flanges, and stiffeners in the model. Reduced integration shell elements, denoted S4R in ABAQUS, were selected to improve computation time, and were found to have no noticeable impact on the results. Computation time is relevant to the use of this model for a finite element parametric study of different eccentrically braced frame geometries.

Nonlinear isotropic hardening plasticity material model available in ABAQUS was used in the finite element model of the proof-of-concept 2/3 scale diagonal eccentrically braced frame. Only monotonic coupon test data were available for the materials used in fabricating the frame. Thus these were input as half cycle data for the material model. Whereas material property of the stiffeners and column was not given in the report, their materials define similar to the beam. No fracture model was employed in the finite element model of the frame. Since global behavior of EBF was studied, all of the segments were merging and the welds were not modeled.

Large displacement effects were accounted for by utilizing the nonlinear geometry option in ABAQUS. At each step, elements were formulated in the current configuration using current nodal positions. By including large displacement effects in the analysis, local buckling could be captured and the post buckling of the link could be simulated. The link loading protocol in experimental test was used in analyzing.

Boundary conditions similar to those employed by Engelhardt and Popov (Fig. 7) were used here. Loading is applied through the

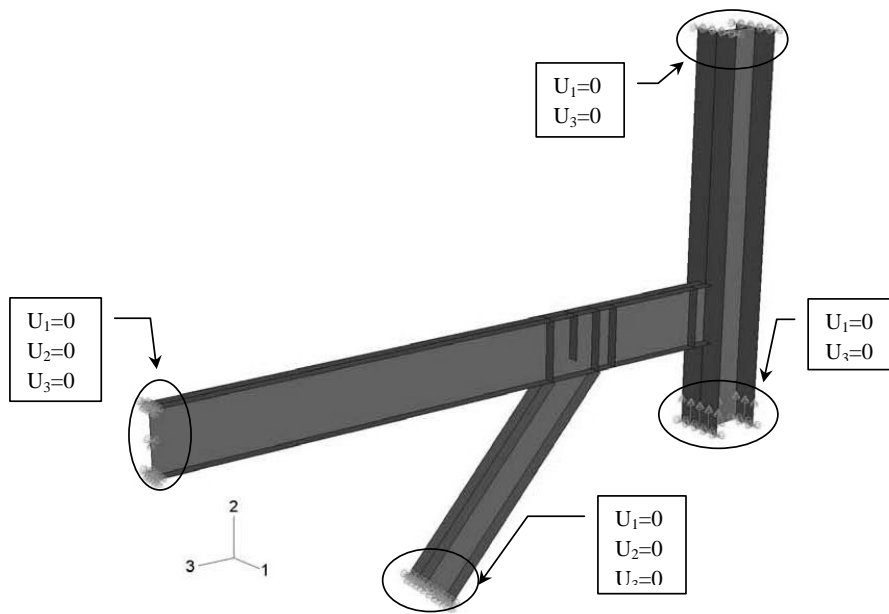

Fig. 7. Boundary conditions of finite element model

application of vertical displacement at the link end. Loads were applied by imposing transverse displacements on the bottom of the column. Top of the column was permitted to move vertically.

As shown in Fig. 5 and 6, good agreement was obtained between the analytical and experimental results in the terms of both their hysteretic behavior and overall deformation patterns. The rotation and link shear at key locations in the finite element model were also near their expected values. The finite element modeling of the prototype EBF also has the same compatibility with the 2/3 scale experimental results, so the program is efficient to model an eccentrically braced frame.

5. Design of Diagonal EBFs with Carbon Steel and Easy Going Steel

As mention before, eccentrically braced frames (EBFs) are expected to withstand significant inelastic deformations in the links when subjected to the forces resulting from the motions of the design earthquake. Link plastic rotation angle (γ_p) can be easily estimated by frame geometry assuming rigid-plastic behavior of the frame members. Depending on the section properties of the link, link may yield either in shear extending over the full length of the link or

in flexure at the link ends, or the combination of shear and flexural yielding. Note that link plastic rotation angle is the same whether the link yields in shear or in flexure. Yielding mechanism of links depends on material properties of links such as moment capacity, shear capacity, and strain hardening. Equations to determine the length ranges and allowable link inelastic rotation angles have been developed for compacted sections are specified in AISC Seismic Provisions [23]:

Short (Shear yielding) links:

$$e \leq 1.6 \frac{M_p}{V_p} \quad \gamma_p = 0.08 \text{ radians} \quad (3)$$

Long (flexural yielding) links:

$$e \geq 2.6 \frac{M_p}{V_p} \quad \gamma_p = 0.02 \text{ radians} \quad (4)$$

Intermediate length (combination of shear and flexural yielding) links:

$$1.6 \frac{M_p}{V_p} \leq e \leq 2.6 \frac{M_p}{V_p} \quad \gamma_p = \text{interpolation between } 0.08 \text{ and } 0.02 \text{ radians} \quad (5)$$

Where $M_p = Z F_y$ is the nominal plastic flexural strength; Z is the plastic section modulus; F_y is the

specified minimum yield stress. $V_p=0.6F_y(d_b-2t_f)t_w$ is the nominal shear strength; d_b is the overall beam depth; t_f and t_w are the thicknesses of the flange and web, respectively.

Key points for designing an EBF in accordance with seismic provisions for structural steel buildings (AISC 2005) are summarized herein. Focus is kept on shear yielding links in this paper.

Inelastic action is intended to occur primarily within the shear links; therefore elements outside the links such as beam segment, diagonal brace, and column should be designed following capacity design approach. That is, these elements should remain essentially elastic under the maximum forces that can be generated by the fully yielded and strain-hardened links. It should be noted that a soft story could form if formation of plastic hinges in columns are combined with the yielded links; therefore plastic hinges should be avoided in the columns.

For shear links, the design shear strength is calculated as:

$$\phi_v V_n = 0.9V_p = 0.9(0.6F_y A_w) = 0.9[0.6F_y(d_b - 2t_f)t_w] \quad (6)$$

Where ϕ_v is the resistance factor which is taken as $0.9F_y$, is the specified minimum yield stress[23]. The yield stresses for carbon steel and EGS that used in the design are 240(MPa) and 90(MPa) respectively. Other parameters are defined previously.

The effect of axial force on the link available shear strength do not need to be considered if $P_u \leq 0.15P_y$; where P_u is required axial strength and P_y is nominal axial yield strength ($P_y=F_y A_g$).

If $P_u \geq 0.15P_y$ The available shear strength of the link shall be the lesser of $\phi_v V_n$ and the following additional requirements shall be met:

1) The available shear strength of the link

$$\phi_v V_{pa} = \phi_v V_n \sqrt{1 - (P_u / P_y)^2} \quad (7)$$

2)The length of the link shall not exceed:

$$a) \left[1.15 - 0.5 \frac{P_u}{V_u} \left(\frac{A_w}{A_g} \right) \right] \times 1.6 \frac{M_p}{V_p} \text{ When } \frac{P_u}{V_u} \left(\frac{A_w}{A_g} \right) \geq 0.3 \quad (8)$$

Nor

$$b) 1.6 \frac{M_p}{V_p} \text{ When } \frac{P_u}{V_u} \left(\frac{A_w}{A_g} \right) < 0.3 \quad (9)$$

Where: $A_w = (d - 2t_f)t_w$

Full-depth web stiffeners shall be provided on both sides of the link web at the diagonal brace ends of the link. These stiffeners shall have a combined width not less than $(b_f - 2t_w)$ and a thickness not less than $0.75t_w$ or 10 mm, whichever is larger[23].

Links of length $1.6 \frac{M_p}{V_p}$ or less shall be provide with intermediate web stiffeners spaced at intervals not exceeding $(30t_w - d/5)$ for a link rotation angle of 0.08 radian. Intermediate web stiffeners shall be full depth. For links that are less than (635 mm) in depth, stiffeners are required on only one side of the link web. The thickness of one-sided stiffeners shall not be less than t_w or 10 mm, whichever is larger, and the width shall be not less than $b_f / 2 - t_w$. For links that are 635 mm in depth or greater, similar intermediate stiffeners are required on both sides of the web. For flanges of I-shaped beams width-thickness ratio is checked though Eq.10.

$$\frac{b_f}{2t_f} \leq 0.38 \sqrt{\frac{E_s}{F_y}} \quad (10)$$

To assure that yielding and energy dissipation in an EBF occur primarily in the links, capacity design approach is adopted for design of the diagonal brace and the beam segment outside the link. That is, the diagonal brace and beam segment outside the link are designed to resist the forces generated by the fully yielded and strain

hardened link. For short links ($e \leq 1.6 \frac{M_p}{V_p}$) the generated forces can be calculated as:

$$\text{Link shear} \quad 1.25 R_y V_p \quad (11)$$

$$\text{Link end moment at column} \quad R_y M_p \quad (12)$$

$$\text{Link end moment at brace} \quad [e(1.25 R_y V_p - R_y M_p) \geq 0.75 R_y M_p] \quad (13)$$

Where R_y is the ratio of the expected yield strength to the minimum specified yield strength F_y prescribed in AISC Seismic Provisions (AISC 2005). For Hot-rolled structural shapes (ASTM A36), $R_y=1.5$ is assumed. This ratio is used to account for possible material overstrength.

However, for the design of the beam segment outside the link, the required beam strength based on only 1.1 times the link expected shear strength is allowed by the Provisions through Eq.14.

$$\text{Link shear} = 1.1 R_y V_p \quad (14)$$

This relaxation on link ultimate forces results primarily from the recognition that beam strength will be considerably increased due to the

presence of composite slab. Also, limited yielding is sometime unavoidable and will not cause deterioration of the energy dissipation as long as stability of the beam is assured[24].

Similar to the diagonal brace and beam segment outside of the link, the columns of an EBF also are designed using capacity design principles. That is, the columns should be designed to resist the maximum forces developed by the fully yielded and strain hardened links. As discussed before, the maximum shear force developed by a fully yielded and strain hardened link can be estimated as $1.25R_y$ times of the link nominal shear strength V_n , where the 1.25 factor accounts for strain hardening. For capacity design of the columns, AISC permits reduction of

Table 3. Designed specimen- dimensions sections

Specimen	Height(m)	Span (m)	Link length(m)	Beam section	Braced section	Column Section	Stiffeners Spacing(m)
H3S3		3.0	0.45	IPE200	2UNP120	IPB160	0.12
H3S4		4.0	0.45	IPE200	2UNP120	IPB200	0.12
H3S5	3.0	5.0	0.40	IPE200	2UNP120	IPB220	0.12
H3S6		6.0	0.40	IPE220	2UNP140	IPB240	0.13
H3S7		7.0	0.45	IPE240	2UNP200	IPB300	0.13
H4S3		3.0	0.50	IPE200	2UNP160	IPB180	0.12
H4S4		4.0	0.50	IPE200	2UNP140	IPB220	0.12
H4S5	4.0	5.0	0.40	IPE200	2UNP140	IPB240	0.12
H4S6		6.0	0.40	IPE220	2UNP160	IPB280	0.13
H4S7		7.0	0.40	IPE270	2UNP280	IPB320	0.14
H4.5S3		3.0	0.50	IPE200	2UNP160	IPB200	0.12
H4.5S4		4.0	0.50	IPE200	2UNP160	IPB220	0.12
H4.5S5	4.5	5.0	0.50	IPE200	2UNP160	IPB240	0.12
H4.5S6		6.0	0.45	IPE220	2UNP180	IPB280	0.13
H4.5S7		7.0	0.40	IPE270	2UNP350	IPB320	0.14

Table 4. Section dimensions of designed specimens

Member	Section	d (mm)	b _f (mm)	t _w (mm)	t _f (mm)
Beam	IPE200	200	90	7.50	11.30
	IPE220	220	98	8.10	12.20
	IPE240	240	106	8.70	13.10
	IPE270	270	135	6.60	10.20
Column	IPB160	160	160	8.0	13.0
	IPB180	180	180	8.50	14.0
	IPB200	200	200	9.0	15.0
	IPB220	220	220	9.50	16.0
	IPB240	240	240	10.0	17.0
	IPB280	280	280	10.5	18.0
	IPB300	300	300	11.0	19.0
	IPB320	320	320	11.50	20.50
Brace	2UNP120	120	55	7.0	9.0
	2UNP140	140	60	7.0	10.0
	2UNP160	160	65	7.5	10.5
	2UNP180	180	70	8.0	11.0
	2UNP200	200	75	8.5	11.5
	2UNP280	280	95	10.0	15.0
	2UNP350	350	100	14.0	16.0

the strain hardening factor to 1.10. This relaxation reflects the view that all links above the level of the column under consideration will not likely reach their maximum shear strength simultaneously.

The properties of diagonal eccentrically braced frames that designed through AISC 2005 are shown in table 3. As discussed before, all of the sections are of A36 steel. Since the overall beam depths of the links are smaller than 635 mm, all of stiffeners are embedded at one side of the link and their thicknesses are assumed to be 10 mm. Table 4 provides a list of section dimensions and properties for the beams, Braces and column of designed specimens.

In the next step, all of the previous frames are designed by using EGS in the beam. To have equal shear capacities in the beam made of EGS,

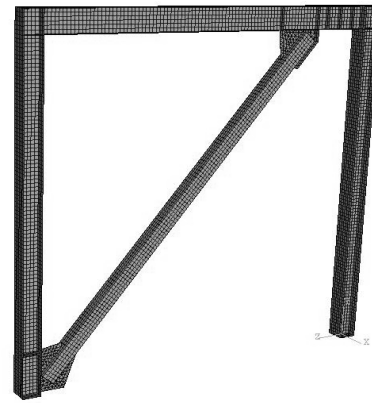

(a)

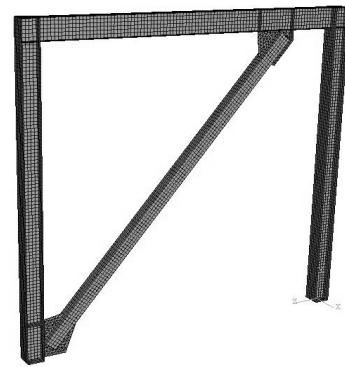

(b)

Fig. 8. Finite element model of one of designed eccentrically braced frame with (a) Carbon Steel (b) Easy-Going Steel

the section area of the beam with EGS should be increased by the ratio of yield stress of carbon steel to that of EGS. Using the specifications of the Easy-Going and carbon steel used in this paper, the dimensions of the link made by EGS is calculated from the dimensions of the specimen made of carbon steel. So the thicknesses of the flange and web of the beam sections are multiplied by:

$$\frac{240}{90} = 2.667$$

Through AISC Seismic Provisions, these links do not need any intermediate web stiffeners, because the stiffeners intervals through $(30t_w - d/5)$ oversize the link length. All of the other sections are of A36 steel and as the same as the previous state.

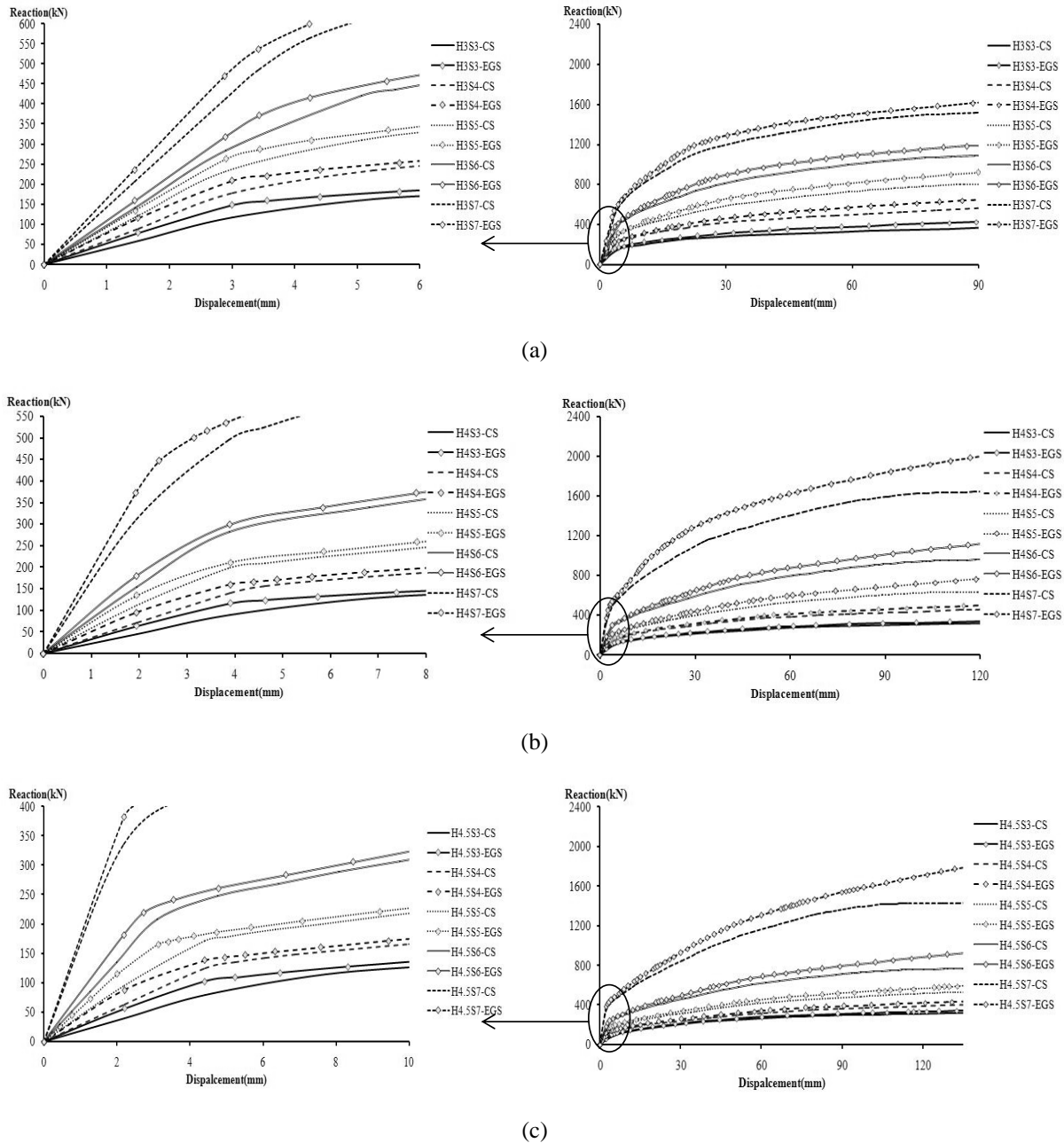

Fig. 9. Comparison of reaction versus displacement curves for CS and EGS series EBF specimens (a) 3m span (b) 4m span (c) 4.5m span

All of the designed EBFs are modeled in ABAQUS program with the same characteristic that used in modeling verification of the program. The ultimate strain of EGS and CS was assumed 0.4 and 0.21 respectively in the program, while modulus of elasticity of them was considered the same. Fig. 8 shows one of eccentrically braced frames with carbon steel and EGS.

The bases of the columns are defined fix and they could not rotate or translate in any direction, and a lateral load is applied at the top of each EBF. According to the AISC 2005, static analysis with a target displacement equal to 3% of the height of every frame was conducted for all specimens. The results are presented in the force-displacement curves in Fig. 9.

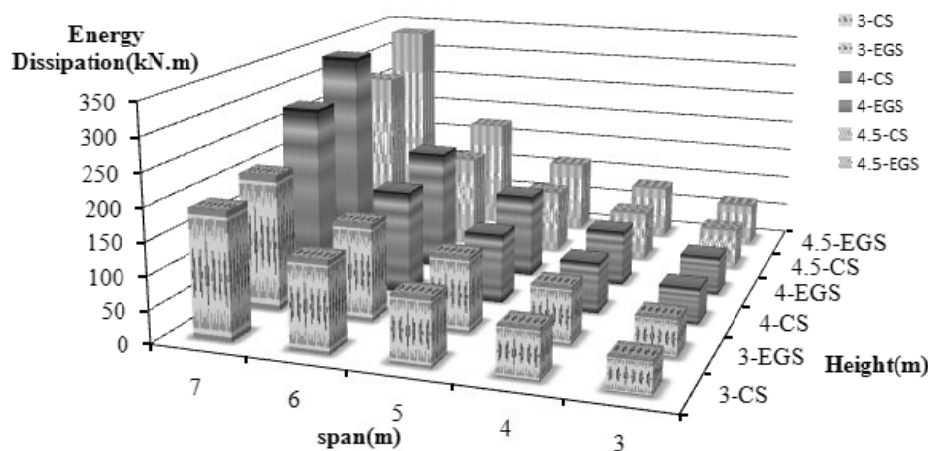

Fig. 10. Distribution and energy dissipation applied to systems and link contribution

As shown in Fig. 9, elastic stiffness of the Easy-Going Steel specimens increased relative to carbon steel eccentrically braced frames. To compare the effect of EBFs made of EGS to those of traditional steel, the energy dissipation in specimens based on energy dissipated by the links are shown in Fig. 10.

The EBFs made from EGS links not only have more ductility and ability of dissipating more energy of applied load, but also their lateral displacement relevant to similar lateral load decrease considerably.

6. Summery and Conclusions

In this paper the Easy-Going Steel concept introduced for using in diagonal eccentrically braced frame which has a lower yield stress than carbon steel.

For this purpose the 2/3 scale eccentrically braced frame which had tested by Engelhardt and Popov (1989) was used. After calibration of the EBF with ABAQUS program, fifteen diagonal EBFs were designed through seismic provisions for structural steel buildings (AISC 2005) with carbon steel and EGS and a monotonic lateral load was applied to the top of each EBF until lateral displacement of the frame becomes 3%. Then the EGS was replaced in the link segment. Therefore, the thickness of web and flanges of the link increased for equal shear capacity. The results show that by using lowest strength steel in shear link of EBFs, the shear stiffness of the link increases substantially and by thickening the link web plate as a result of using

EGS, it does not buckle. Moreover, using shear links made of EGS increases the total energy dissipated by the eccentrically braced frames.

References

- [1]. Krawinkler, H., Bertero, V.V., and Popov, E.P.: 1971, Inelastic Behavior of Steel Beam-to-Column Subassemblies, Report No. 71/7, Earthquake Engineering Research center, University of California, Berkeley
- [2]. Popov, E.P.: 1981, Recent research on eccentrically braced frames, proceeding, Structural engineering association of California, pp. 69-80, Coronado, Sept
- [3]. Pauley, T.: 1983, Deterministic Seismic Design Procedures for Reinforced Concrete Buildings, Engineering Structures, Vol. 5, No.1, 79-86, Jan.
- [4]. Black, K.G., Wenger, W.A., and Popov, E.P.: 1980, Inelastic Buckling of Steel Struts Under Cyclic Load Reversal, Report 80/40, Earthquake Engineering Research center, University of California, Berkeley
- [5]. Maison, B.F., and Popov, E.P.: 1980, Cyclic Response Prediction for Braced Steel Frames, Journal of the Structural Division, ASCE, 106, No. ST7, July, pp. 1401-1416
- [6]. Spurr, H.V.: 1930, Wind Bracing, Mcgraw-Hill, New York

- [7]. Hisatoku, T., et. al.: 1971, Experimental Study on the Static Behavior of the Y-Typed Bracings, Report of Takenaka Technical Institute, No. 12, Aug.
- [8]. Fujimoto, M., Aoyagi, T., Ukai, K., Wada, A., and Saito, K.: 1972, Structural Characteristics of Eccentric K-Braced Frames, Trans AIJ, No. 195, May
- [9]. Roeder, C.W., and Popov, E.P.: 1977, Inelastic Behavior of Eccentrically Braced Steel Frames Under Cyclic Loadings, Report No. 77/18, Earthquake Engineering Research center, University of California, Berkeley
- [10]. Roeder, C.W. and Popov, E.P.: 1978, Eccentrically Braced Frames for Earthquakes, J. Struct. Div. ASCE 104, No. ST3, 391-412, Mar.
- [11]. Manheim, D.N.: 1982, On the Design of Eccentrically Braced Frames, D. Eng. Thesis, Department of Civil Engineering, University of California, Berkeley, Feb.
- [12]. Kasai, K. and Popov, E.P.: 1986 Cyclic Web Buckling Control for Shear Link Beams, Journal of the Structural Division, vol. 112, No. 3, ASCE, Mar.
- [13]. Hjelmstad, K.D. and Popov, E.P.: 1983, Seismic Behavior of Active Beam Links In Eccentrically Braced Frames, Report No. 83/24, Earthquake Engineering Research center, University of California, Berkeley
- [14]. Malley, J.O. and Popov, E.P.: 1983, Design Considerations for Shear Links in Eccentrically Braced Frames, Report No. 83/24, Earthquake Engineering Research center, University of California, Berkeley
- [15]. Engelhardt M.D. and Popov, E.P.: 1989, Behavior of Long Links in Eccentrically Braced Frames, Report No. 89/01, Earthquake Engineering Research center, University of California, Berkeley
- [16]. Richards, P., and Uang, C.M.: 2003, Development of testing protocol for short links in eccentrically braced frames. Rep. No.2003/08, Dept. of Structural Engineering, Univ. of California at San Diego, a Jolla, California
- [17]. Okazaki T, Arce G, Ryu HC, Engelhardt MD.: 2005, Experimental study of local buckling, overstrength, and fracture of links in eccentrically braced frames. Journal of Structural Engineering-ASCE; Vol. 131, No. 10, pp1526–1535
- [18]. Chao, S.H., Khandelwal, K., and El-Tawil.S.: 2006, Ductile Web Fracture Initiation in Steel Shear Links, Journal of structural engineering, Vol. 132, No. 8, pp 1192-1200
- [19]. Sabouri-Ghomi, S.: 2004, Lateral load resisting systems and innovative idea to application of Easy-Going Steel: EGS, Angizeh publishing Company
- [20]. Kasai, K. and Popov, E.P.: 1986, A Study of Seismically Resistant Eccentrically Braced Frames, Report No. 86/01, Earthquake Engineering Research Center, University of California, Berkeley
- [21]. Lay, M.G.: 1965, Flange Local Buckling in Wide-Flange Shapes, Journal of the Structural Division, Vol. 91, No. ST6, Dec.
- [22]. Hibbitt, Karlsson, and Sorensen: HKS: 2001, ABAQUS standard user's manual
- [23]. AISC. Seismic provisions for structural steel buildings: 2005, American Institute of Steel Construction
- [24]. Chao S. H., and Goel, S.C.: 2005, Performance-base seismic design of EBF using target drift and yield mechanism as performance criteria, A report on research partly sponsored by the American Institute of Steel Construction 05/05, Department of Civil and Environmental Engineering The University of Michigan College of Engineering