

Comparison of Different Methods of Wavelet and Wavelet Packet Transform in Processing Ground Motion Records

G. Ghodrati Amiri* and A. Asadi

Received: February 2009

Accepted: October 2009

Abstract: Future design procedures for civil structures, especially those to be protected from extreme and blast related loads, will need to account for temporal evolution of their frequency content. There are, however, several instances where acceleration time histories are required as seismic input. For example, to determine the ultimate resistance and to identify modes of structures' failure, a nonlinear time history analysis is needed. In other cases, acceleration time histories are required for linear analyses. Many seismic codes require this type of analysis for buildings which have irregularities. The process of time-frequency analysis made possible by the wavelet transform provides insight into the character of transient signals through time-frequency maps of the time variant spectral decomposition that traditional approaches miss. In this paper an approach is examined and a new method for processing the ground motion which is modeled as a non-stationary process (both in amplitude and frequency), is proposed. This method uses the best basis search algorithm with wavelet packets. In this approach, the signal is expressed as a linear combination of time-frequency atoms which are obtained by dilations of the analyzing functions, and are organized into dictionaries as wavelet packets. Several numerical examples are given to verify the developed models.

Keywords: wavelet packet transform; artificial accelerogram; best-basis algorithm frequency content.

1. Introduction:

In earthquake engineering, the strong non-stationary characteristics both in time domain and frequency domain, i.e. amplitude and frequency, of the earthquake ground motion are well known and difficult to tackle in applying the ground motion as an input to acquire the structure responses. While response spectra method is currently the favored approach, there are situations for which the time history analysis is necessary. Since the number of recorded accelerograms is too limited to allow selection of a standard typical record for a given site, there is a need for generating some realistic artificial earthquake ground motion records to cover a variety of uncertainties in the seismic design of structures [1]. Spectral analysis using the Fourier transform has been one of the most important and most widely used tools in earthquake engineering, but there are cases for which the Fourier analysis does not provide results that can

physically be interpreted. Over the past few years, however, researchers have become aware of the limitations of this technique, especially in the case of non-stationary signals and nonlinear systems. As a new method with an obvious advantage for the time-frequency analysis, the wavelet transform is now applied in many fields of studies. Wavelets are a natural extension of the Fourier analysis. A wavelet is a small wave whose energy is concentrated in time [2]. Wavelet transform is a good tool adaptive to time-frequency analysis in earthquake engineering and has a good

time-frequency discrimination ability. Wavelet transform can improve the studies of earthquake engineering from conventional frequency spectrum analyses to more accurate time-frequency analyses.

Newland [3] applied wavelets to analysis of the vibration signals and developed special wavelets and techniques for engineering purposes. Iyama and Kuwamura [4], Mukherjee and Gupta [5], Zhou and Adeli [6], Suarez and Montejo [7], Rajasekaran et al. [8], and Ghodrati Amiri et al. [9] developed the wavelet analysis for generating earthquake accelerograms. With good time-frequency discrimination ability and flexible time-frequency windows, wavelet

* Corresponding Author: ghodrati@iust.ac.ir

Center of Excellence for Fundamental Studies in Structural Engineering, School of Civil Engineering, Iran University of Science & Technology, PO Box 16765-163, Narmak, Tehran 16846, IRAN

transforms are now widely used for analysis of various signals in time and frequency domain simultaneously.

Both Fourier and wavelet analysis have limitations. Fourier analysis gives good results for regular periodic signals and wavelet analysis is suitable for highly non-stationary signals that possess sudden picks and discontinuities. Other approaches have been examined and several algorithms and analyzing functions have already been proposed [10]. One of them is the best basis search algorithm which uses wavelet packets. In this approach, the signal is expressed as a linear combination of time-frequency atoms. The atoms are obtained by dilation of the analyzing functions and are organized into dictionaries as wavelet packets. The best basis algorithm uses a minimum entropy criterion and for a signal, gives the most concise description for the dictionary in hand.

2. Wavelet and Wavelet packet transform

Wavelet transform is a mathematical tool which transforms sequential data in time axis such as earthquake accelerations to the spectral data in both time and frequency. Therefore, wavelet transform provides information on non-stationary time dependent intensity of motions regarding a particular frequency of interest. Wavelets are mathematical functions that cut up data or function into different frequency components, and then study each component with a resolution matched to its scale [11]. Wavelets, which are oscillatory functions of zero mean and of finite energy, can be used to obtain a time-frequency representation of a process.

Due to decomposition of only the approximation component at each level using the dyadic filter bank, in a regular wavelet analysis the results of frequency resolution in higher-level DWT decompositions (e.g. A1 and D1) are less desirable (Figure 1). It may cause problems while applying DWT in certain applications which the important information is located in higher frequency components. The frequency resolution of the decomposition filter may not be fine enough to extract necessary information from the decomposed component of the signal. The necessary frequency resolution can be achieved by implementing a wavelet packet transform to decompose a signal further. The wavelet packet method is a generalization of wavelet decomposition that offers a richer range of possibilities for signal analysis. In wavelet analysis, a signal is split into an approximation and a detail. The approximation is then itself split into a second-level approximation and detail, and the process is repeated. For n-level decomposition, there are n+1 possible ways to decompose or encode the signal. In wavelet packet analysis, the details as well as the approximations can be split. This yields more than different ways to encode the signal. For instance, wavelet packet analysis allows the signal S to be represented as $A1+A6+D6+D3$. This is an example of a representation that is not possible with ordinary wavelet analysis [12]. The wavelet decomposition tree is a part of this complete binary tree. As mentioned above the wavelet packet analysis is similar to the DWT with the only difference that in addition to the decomposition of the wavelet approximation component at each level, the wavelet detail

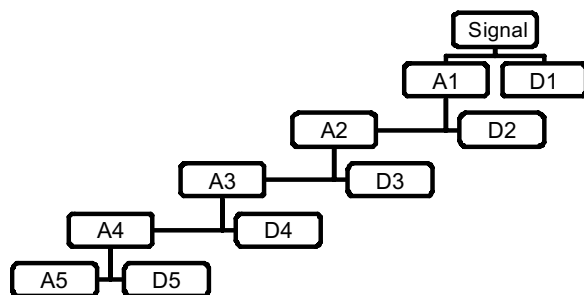

Fig. 1. wavelet tree decomposition

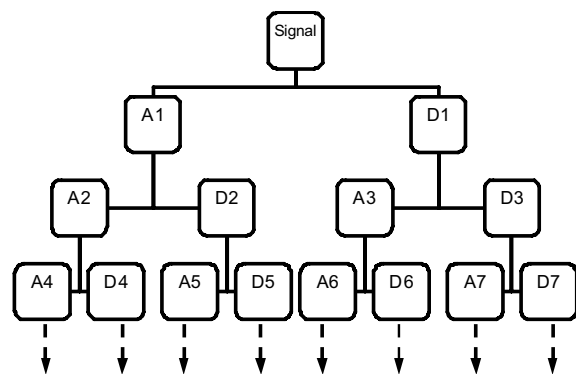

Fig. 2. Wavelet Packet decomposition tree

component is also decomposed to obtain its own approximation and detail components as shown in Figure 2.

Each component in this wavelet packet tree can be viewed as a filtered component with a bandwidth of a filter decreasing with increasing level of decomposition and the whole tree can be viewed as a filter bank. At the top of the tree, the time resolution of the WP components is good but at an expense of poor frequency resolution whereas at the bottom with the use of wavelet packet analysis, the frequency resolution of the decomposed component with high frequency content can be increased. As a result, the wavelet packet analysis provides better control of frequency resolution for the decomposition of the signal [13]. A wavelet packet is represented as a function, ψ , where 'i' is the modulation parameter, 'j' is the dilation parameter and 'k' is the translation parameter [14].

$$\psi_{j,k}^i(t) = 2^{-j/2} \psi^i(2^{-j}t - k) \quad (1)$$

where $i = 1, 2, \dots, jn$ and 'n' is the level of decomposition in wavelet packet tree. The wavelet is obtained by the following recursive relationships:

$$\psi^{2i}(t) = \frac{1}{\sqrt{2}} \sum_{k=-\infty}^{\infty} h(k) \psi^i\left(\frac{t}{2} - k\right) \quad (2)$$

$$\psi^{2i+1}(t) = \frac{1}{\sqrt{2}} \sum_{k=-\infty}^{\infty} g(k) \psi^i\left(\frac{t}{2} - k\right) \quad (3)$$

where $\psi^i(t)$ is called as a mother wavelet and the discrete filters $h(k)$ and $g(k)$ are quadrature mirror filters associated with the scaling function and the mother wavelet function [15]. These two filters, $h(k)$ and $g(k)$, are also called group-conjugated orthogonal filters [16].

The wavelet packet coefficients C corresponding to the signal $f(t)$ can be obtained as:

$$C_{j,k}^i = \int_{-\infty}^{\infty} f(t) \psi_{j,k}^i(t) dt \quad (4)$$

Provided the wavelet coefficients satisfy the orthogonality condition.

The wavelet packet component of the signal at

a particular node can be obtained as

$$f_j^i(t) = \sum_{k=-\infty}^{\infty} C_{j,k}^i \psi_{j,k}^i(t) dt \quad (5)$$

After performing wavelet packet decomposition up to j th level, the original signal can be represented as a summation of all wavelet packet components at j th level as shown in equation:

$$f(t) = \sum_{i=1}^{2^j} f_j^i(t) \quad (6)$$

In wavelet packet, standard structure composed of low and high pass filters is used in perfect reconstruction filter bank [17].

3. Best basis algorithm in wavelet packet transform

The best basis search algorithm uses wavelet packets. In this model the signal is expressed as a linear combination of time-frequency atoms. The atoms are obtained by dilations of the analyzing functions, and are organized into dictionaries as wavelet packets. The best basis algorithm described in Wickerhauser [18] uses a minimum entropy criterion and for a signal gives the most concise description for the dictionary in hand. The application of the best basis search to the wavelet packet dictionary is equivalent to an optimal filtering of the signal. For any given signal, the best basis algorithm decides which base represents the signal more efficiently. Comparisons with other methods of analysis such as wavelet analysis using harmonic wavelets and classic Fourier analysis have been conducted. Wavelet packet atoms are waveforms indexed by three naturally interpreted parameters: position, scale (as in wavelet decomposition), and frequency. For a given orthogonal wavelet function, a library of bases can be generated called wavelet packet bases. Each of these bases offers a particular way of coding signals, preserving global energy, and reconstructing exact features [12]. The wavelet packets can be used for numerous expansions of a given signal. The most suitable decomposition of a given signal can be selected with respect to an entropy-based criterion. The application of the best basis search for the wavelet packet dictionary is

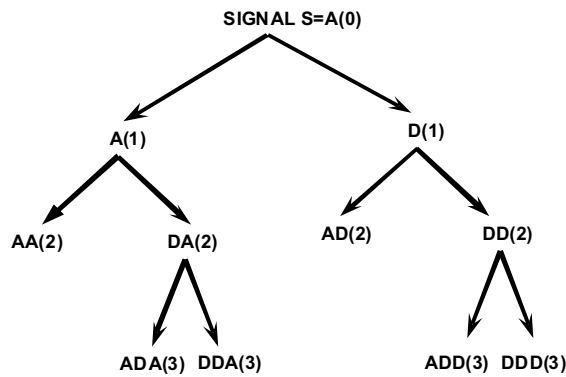

Fig. 3. Wavelet packet tree (Best-tree)

equivalent to an optimal filtering of the signal. For any given signal, the best basis algorithm decides which base represents the signal more efficiently (Figure 3).

4. Choosing the Optimal Decomposition

Based on the organization of the wavelet packet library, it is natural to count the decompositions issued from a given orthogonal wavelet. As a result, a signal of length $N=2^L$ can be expanded in at most 2^N different ways, the number of binary subtrees of a complete binary subtree of depth L . As this number may be very large, and since explicit enumeration is generally unmanageable, it is interesting to find an optimal decomposition with respect to a convenient criterion, computable by an efficient algorithm.

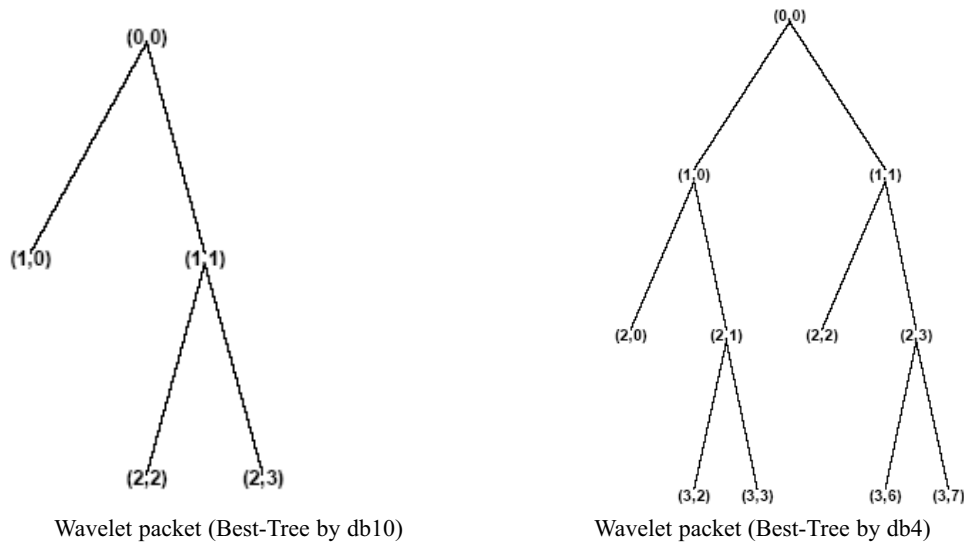

Fig. 4. Different kinds of wavelet packet best basis tree for the same signal

Functionals verifying an additivity-type property are well suited for efficient searching of binary-tree structures and the fundamental splitting. Classical entropy-based criteria match these conditions and describe information-related properties for an accurate representation of a given signal. Entropy is a common concept in many fields, mainly in signal processing [19].

5. Proposed method

Generally, the main idea of the proposed method is to use wavelet packet with best-basis algorithm theory. In this study, coefficients of wavelet packet and inversion are calculated using best-basis algorithm by entropy-based. An entropy-based criterion is used to select the most suitable decomposition of a given signal and also an adaptive filtering algorithm, based on work by Coifman [19] and Wickerhauser [18]. Such algorithms allow the wavelet packet tools to include "Best Tree" features that optimize the decomposition both globally and nodally.

Many mathematical forms for wavelet function have been developed by Daubechies [20], Chui [21], Meyer [22] and many other researchers. In this approach we compare different forms of Daubechies's (db's). The records are decomposed with different forms of db's to compare the results with each other. For example different kinds of wavelet packet tree for using wavelet packet transform with best basis algorithm are shown in

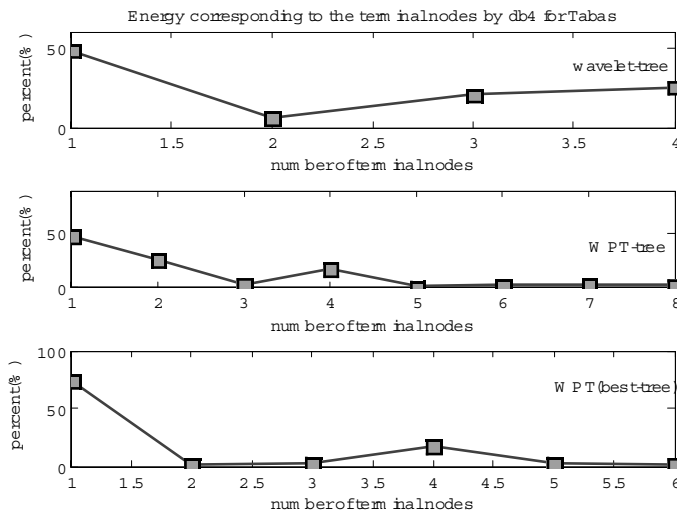

Fig. 5. Energy corresponding to the terminal nodes of reconstructed signal by db4 for Tabas

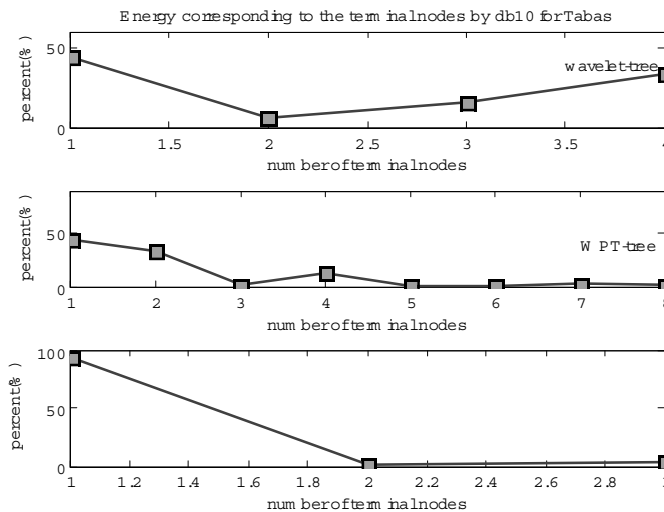

Fig. 6. Energy corresponding to the terminal nodes of reconstructed signal by db10 for Tabas

figure 4. Although the wavelet tree and wavelet packet tree are the same while using db4 and db10, they are different when the wavelet packet with the best basis algorithm is applied (Figure 4). The energy corresponding to the terminal nodes used for the signals' reconstruction is plotted in figure 5 for three different methods which allow a comparison among them. It can be seen that the maximum energy corresponding to the terminal nodes by using db4 for wavelet, wavelet packet and wavelet packet with best tree are %48.373, %48.3670, and % 73.8764 respectively (Figure 5). If this comparison is being done with db10 the results are % 44.7728, %44.7624, %94.3793 respectively (Figure 6). It shows that db10 gives more better and efficient results with less nodes

because of its orthogonality and satisfactory resolution in both time and frequency. For choosing entropy several models such as Non-normalized Shannon entropy, energy entropy, log energy entropy, threshold entropy, SURE entropy and also several others are applied and finally threshold is selected as the entropy with the value 0.2.

After signals are decomposed with the wavelet transform, wavelet packet transform and wavelet packet transform with best basis algorithm, they are reconstructed with these methods and also with only one coefficient of the last method which corresponds to the maximum energy. The results are shown in figure 7 for db10 and figure 10 for db4.

For verifying the results in another way the response spectrum of the reconstructed signals

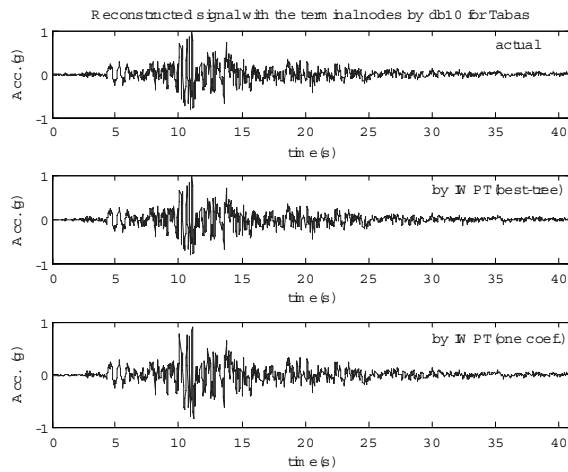
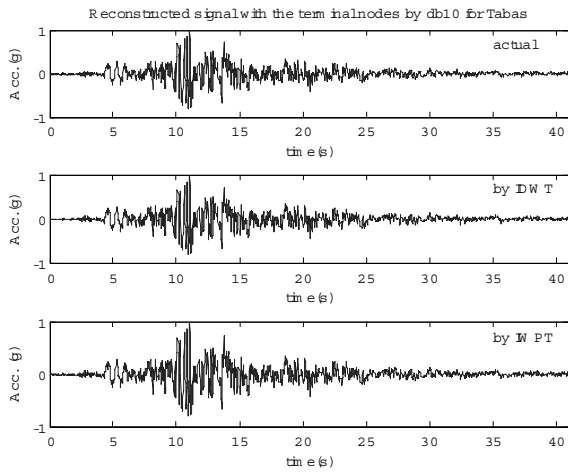

Fig. 7. Comparison of reconstructed signals with the terminal nodes with different methods for Tabas by db10

with different methods are computed and compared with each other. The response spectrum is a plot of the maximum responses of all possible single degree-of-freedom systems due to a specified load function. It can take the form of any quantity of interest, e.g. displacement, velocity, acceleration, etc., and is usually plotted versus the natural frequency or period range of the system under investigation. The pseudo-acceleration and pseudo-velocity of the reconstructed signal with different methods and actual signal are computed and the results are shown in figures (8-9) using db10 and in figures (11-12) using db4. It is interesting that wavelet packet transform with best basis method and selecting just one coefficient result in an answer much more near to the actual signal. In order to verify the error of the process while calculating

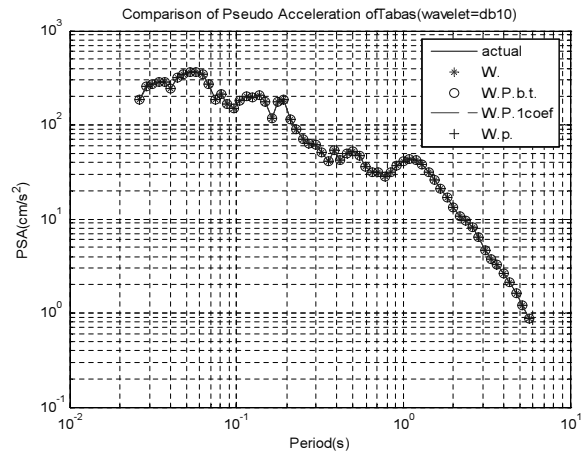

Fig. 8. Comparison of PSA for actual and reconstructed signal by different methods for Tabas by db10

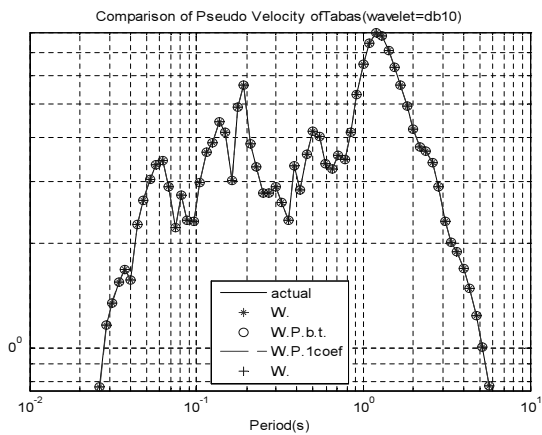

Fig. 9. Comparison of PSV for actual and reconstructed signal by different methods for Tabas by db10

PSA and PSV, an error measure is needed. It is proposed to use the Root-Mean-Square of the differences in percentage at each of the N periods. For example the error for PSA is calculated as follows:

$$e(\%) = \sqrt{\frac{1}{N} \sum_{j=1}^N \left(\frac{(PSA)_{recons.} - (PSA)_{actual}}{(PSA)_{actual}} \right)^2} * 100 \quad (7)$$

According to figure 13 the error for computing PSA and PSV which occurs in reconstructed signal with wavelet, wavelet packet with best basis and only one coefficient of this method with maximum energy is %0.3641 using db10, and in figure 14 it is %13.0467 using db4. One more result is that db10 works much more accurate. It means that the signal can be reconstructed and used by this method in less

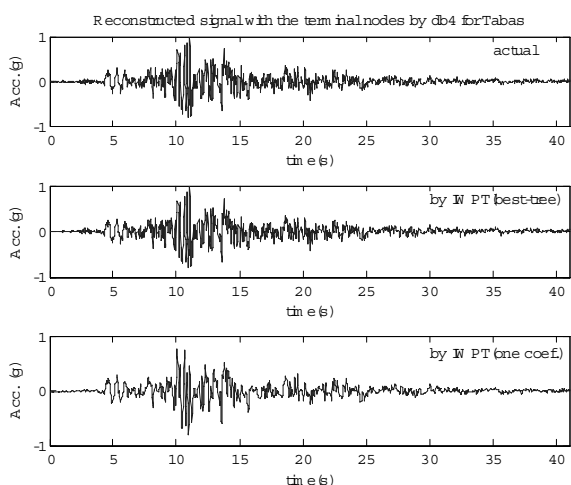
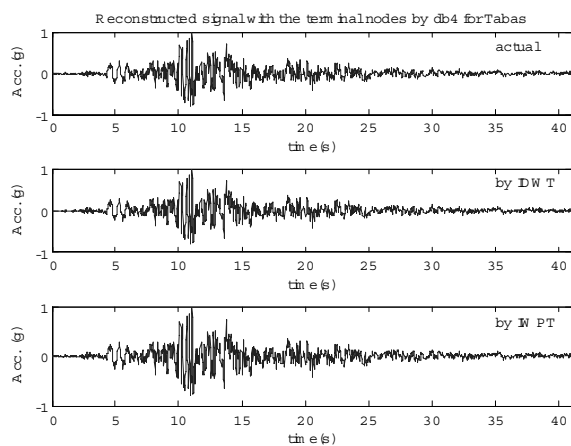

Fig. 10. Comparison of reconstructed signals with the terminal nodes with different methods for Tabas by db4

time with the least coefficients.

6. Numerical examples

This study has been accomplished for 4 selected records of Iran with different types of soil [23]. The records are Tabas (1978), Manjil (1990), Gachsar (1990) and Naghan (1976). These records were scaled with their peak ground acceleration to 1g. In this study all records have $\Delta t=0.02$ sec, and $2^{11}=2048$ points consequently. Therefore a series of zeros were added to the records which were shorter than desired length to gain the proper length and for the longer ones, the strong duration of records with longer length was considered according to MacCann and Shah Algorithm [24]. All pseudo-velocity response spectra were calculated with 5 percent damping ratio [25]. The Mallat algorithm is in fact a

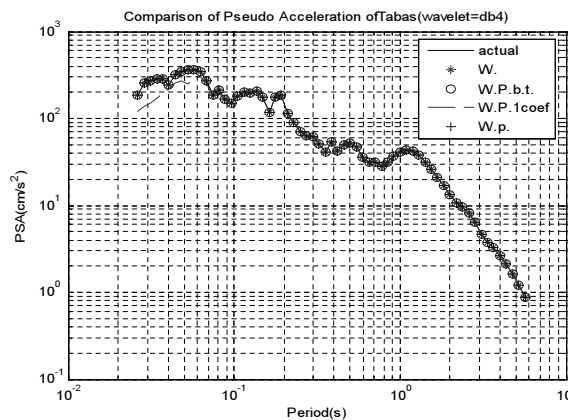

Fig. 11. Comparison of PSA for actual and reconstructed signal by different methodes for Tabas by db4

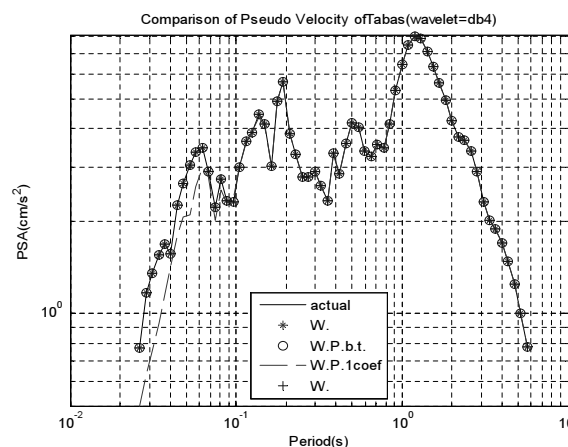

Fig. 12. Comparison of PSV for actual and reconstructed signal by different methodes for Tabas by db4

classical scheme known in the signal processing community as a two-channel sub band coder [26]. This very practical filtering algorithm yields a fast wavelet transform — a box into which a signal passes, and out of which wavelet coefficients quickly emerge. So in this study, coefficients of wavelet and inversion were calculated with Mallat Discrete Wavelet Transform (DWT and IDWT), respectively [27]. In this section, the proposed method has been applied with MATLAB software [12] for all types of earthquake records. Due to the limitation only the results of Tabas are shown in this paper.

7. Conclusion

In this study, the wavelet packet transform with best-basis algorithm was used, which can

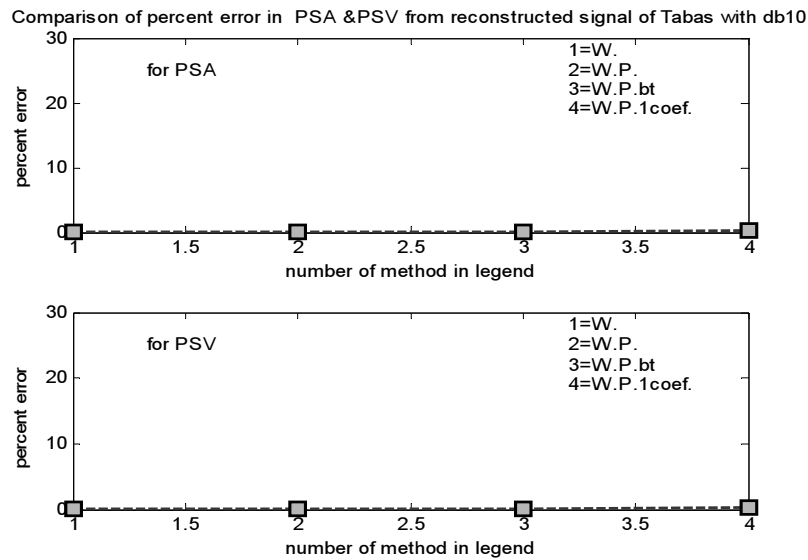

Fig. 13. Comparison of percent error in PSA and PSV from actual and reconstructed signal with different methods for Tabas by using db10

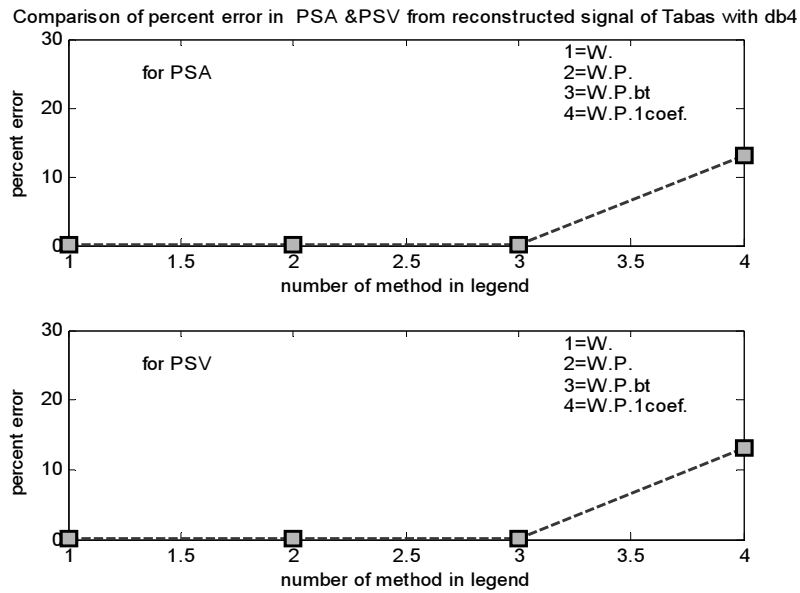

Fig. 14. Comparison of percent error in PSA and PSV from actual and reconstructed signal with different methods for Tabas by using db4

express time signal by combination of similar time shifted wavelets with different time spans. As expected, the adopted method gives better results compared with other methods of analysis such as wavelet basis analysis. According to graphs, the results of WPT using best-basis algorithm shows that only a group of the coefficients (not all of them) can reconstruct original signal. It is interesting that by applying this method to the best tree there is a coefficient that has maximum energy and can reconstruct the

signal.

The advantages of this method can be summarized as follows:

- 1- The over complete structure of WPT provides flexibility for the signal representation to achieve better classification accuracy.
- 2- The best basis provides the most suitable frequency sub bands for the signal representation.
- 3- The subject-based adaptation feature extraction with this method constructs a wavelet packet best basis fitted for each object and so it

can find the suitable and specific features for a subject's signals.

This method and its resulted coefficients (even one coefficient) help to reconstruct the signals rapidly. The feasibility and reliability of the proposed method have been verified with different accelerograms from Iran. As mentioned above by this method in less time with the least coefficients, the signal can be reconstructed and its results can be used in other studies.

References

- [1] Fan, F.G. and Ahmadi, G. (1990), "Nonstationary Kanai-Tajimi models for El Centro 1940 and Mexico City 1985 earthquake", *Prob Engineering Mechanic* 5, 171-181.
- [2] Daubechies I. (1992). "Ten lectures on wavelets". CBMS - NSF Conference Series in Applied Mathematics, Montpelier, Vermont.
- [3] Newland, D.E. (1994), "Random Vibrations, Spectral and Wavelet Analysis", 3rd Edition, Longman Singapore Publishers.
- [4] Iyama, J. and Kuwamura, H. (1999), "Application of wavelets to analysis and simulation of earthquake motions", *Earthquake Engineering & Structural Dynamics*, 28, 255-272.
- [5] Mukherjee, S. and Gupta, K. (2002), "Wavelet-based characterization of design ground motions", *Earthquake Engineering & Structural Dynamics*, 31, 1173-1190.
- [6] Zhou, Z. and Adeli, H. (2003), "Wavelet energy spectrum for time-frequency localization of earthquake energy ", *Computer-Aided Civil Infrastructure Eng*, 13, 133-140.
- [7] Suarez, L.E. and Montejo, L.A. (2005), "Generation of artificial earthquake via the wavelet transform", *Solids and Structures*, 42, 5905-5919.
- [8] Rajasekaran, S., Latha, V. and Lee, S.C. (2006), "Generation of artificial earthquake motion records using wavelets and principal component analysis", *Journal of Earthquake Engineering*, 10(5), 665-691.
- [9] Ghodrati Amiri, G., Ashtari, P. and Rahami, H. (2006), "New development of artificial record generation by wavelet theory", *Structural Engineering and Mechanics*, 22(2), 185-195.
- [10] Jaffard S., Meyer Y., and Ryan RD (2001), "Wavelets: tools for science & technology", Society for Industrial and Applied Mathematics. Philadelphia
- [11] Benedetto, J.J. Frazier, M.W. (1994), "WAVELETS: Mathematics and Applications" Boca Raton: CRC Press.
- [12] MATLAB Reference Guide (1999), The Math Works Inc 13.
- [13] Abhijeet Shinde D., (2004) "A Wavelet Packet Based Sifting Process and Its Application for Structural Health Monitoring". Master Thesis, Faculty of Worcester Polytechnic Institute
- [14] Ogden RT. (1997), "Essential Wavelets for Statistical Applications and Data Analysis". Birkhauser, Boston,
- [15] Ghodrati Amiri G, Bagheri A. and Razaghi A., (2008), "Generation of multiple earthquake accelerograms compatible with spectrum via the wavelet packet transform and stochastic neural networks", *Journal of Earthquake Engineering* (Accepted for publication).
- [16] Fan X, Zuo MZ. (2006), "Gearbox fault detection using Hilbert and wavelet packet transform", *Mechanical Systems and Signal Processing*, 20:966 -982.
- [17] Strang, G., Nguyen, T. (1996), "Wavelets and Filter Banks", Wellesley-Cambridge Press, Wellesley, Massachusetts
- [18] Wickerhauser MV (1994), "Adapted wavelet analysis from theory to software" A.K. Peters.

Wellesley, MA.

- [19] Coifman, R.R.; M.V Wickerhauser (1992), "Entropy-based algorithms for best-basis selection," IEEE Trans. on Inf. Theory, 38(2), 713-718
- [20] Daubechies I., (1988) "Orthonormal bases of compactly supported wavelets", Communication Pure Applied Mathematic 41, 909-996
- [21] Chui,C.K. an Wang,J.Z.(1992), "On compactly supported spline wavelets and a duality principle", rans. Amer. Mathematic Soc. 330 903-915
- [22] Meyer, Y. (1989), "Orthonormal Wavelets ", in wavelets, Proc. Int. Conf. France, Springer, Berlin.
- [23] Ramezi, H. (1997), "Base Accelerogram Data of Iranian Accelerograph Network", Building and Housing Research Center, BHRC-PN S 253, Tehran, Iran.
- [24] MacCann, W.M. and Shah, H.C. (1979), "Determining strong-motion duration of earthquake", Bulletin of the Seismological Society of America, 69, 1253-1265.
- [25] Naeim, F. (1999),"The Seismic Design Handbook", Van Nostrand.
- [26] Strang, G, Nguyen, T., 1996. "Wavelets and Filter Banks" Wellesley-Cambridge Press, Wellesley, Massachusetts
- [27] Mallat, S.G., (1999), "A Wavelet Tour of Signal Processing", Second edition Academic press, London, United Kingdom.