

Bus fleet optimization using genetic algorithm a case study of Mashhad

Sh. Afandizadeh^{1,*}, H. Khaksar², N. Kalantari²

Received: May 2011, Revised: June 2011, Accepted: April 2012

Abstract

In this paper, a new approach was presented for bus network design which took the effects of three out of four stages of the bus planning process into account. The presented model consisted of three major steps; 1- Network Design Procedure (NDP), 2- Frequency Determination and Assignment Procedure (FDAP), and 3- Network Evaluation Procedure (NEP). Genetic Algorithm (GA) was utilized to solve this problem since it was capable of solving large and complex problems. Optimization of bus assignment at depots is another important issue in bus system planning process which was considered in the presented model. In fact, the present model was tested on Mandl's bus network which was a benchmark in Swiss network and was initially employed by Mandl and later by Baaj, Mahmassani, Kidwai, Chakroborty and Zhao. Several comparisons indicated that the model presented in this paper was superior to the previous models. Meanwhile, none of the previous approaches optimized depots assignment. Afterwards, sensitivity analysis on GA parameters was done and calculation times were presented. Subsequently the proposed model was evaluated; thus, Mashhad bus network was designed using the methodology of the presented model.

Keywords: Assignment, Genetic, Network design.

1. Introduction

Bus system is one of the most important parts of the integrated transportation system. Proper design of bus network has a significant role in increasing the utility of this mode from users' point of view and can reduce transportation system cost. Although many studies have been conducted in this regard, none of them could solve it approximately. Designing a bus network involves four major stages: 1- Network design, 2- Timetable development, 3- Bus scheduling, and 4- Driver scheduling [1]. The first stage is optimization of bus routes based on the demand matrix. The next stage involves proper determination of bus frequencies on each route with respect to the demand matrix. Scheduling optimal fleet to the routes based on the predetermined timetables (in stage 2), budget limits and location of the depots will be considered in this stage. In the fourth and final stages, fleet crew and their roster table will be assigned in the

fourth stage [2]. It is highly desirable to optimize all the four stages simultaneously in order to exploit system capability to the greatest extent and to maximize system performance and efficiency. However, this is an extremely cumbersome and complex process; therefore, it requires a separate treatment of each stage with the outcome of one stage fed as an input to the next. In the past three decades, a lot of effort has been put into investigating the computerization of the four components mentioned previously in order to provide more efficient, controllable and responsive schedules.

Proper and careful designing of each of the aforementioned stages will play an effective and undeniable role in the performance of the urban bus transport system. In spite of the extensive studies that have been carried out to optimize these stages, no study has been conducted to optimize all the stages simultaneously. Hitherto, in the majority of the studies which have been done so far, all these stages have been optimized individually due to the complexity of the problem and the number of the parameters and variables involved not been put into practice.

A number of important previous studies are summarized in Section 2. The third section presents the proposed objective function and constraints. The solution methodology will be described in Section 4, which includes three main parts: Network design algorithm, Route assignment algorithm and

* Corresponding Author: zargari@iust.ac.ir

¹ Associate Professor, Dept. of Civil Engineering, Iran University of Science and Technology

² PHD Candidate, Transportation Engineering, Dept. of Civil Engineering, Iran University of Science and Technology

Evaluation algorithm. In Section 5, the proposed model will be used to design the bus network on an example network (Mandl) and will be compared with previous studies. Sensitivity analysis of genetic parameters is conducted in Section 6. Mashhad bus network design is presented in Section 7 and concluding remarks are presented in Section 8.

2. Previous Studies

Previous research related to bus network design problem can be categorized into four classes: 1- the models that optimize only bus route configuration, 2- the models which primarily optimize configuration of bus routes and then determine their optimal frequency, 3- the models which simultaneously optimize routes and their frequency, and 4- the models that sequentially optimize route configurations, frequencies and buses schedules.

The model proposed by Lampkin and Saalmans first determined the routes of the bus networks and afterwards, in the second stage, assigned frequencies to the generated set of routes [3]. Silman et al. presented a two staged approach; first, the candidates' set of routes were constructed and then the optimal frequencies were determined for a set of already-generated routes [4]. Mandl's methodology had three stages: (i) assigning passengers to routes, (ii) assigning vehicles to routes, and (iii) finding vehicle routes in a given network of streets [5]. The network generation problem was categorized into three sub-problems by Dubois et al. which included choosing a set of streets, choosing a set of bus lines and determining optimal frequencies [6]. Ceder and Wilson placed the bus network design activity in the context of other bus service functions including setting frequencies, timetable development, bus scheduling and driver scheduling [1]. In the research conducted by Leblanc, a transit network design model was proposed for frequency optimization of the existing transit routes [7]. A model was presented by Van Nes et al. for designing public transport network that maximized the number of direct trips given a certain fleet size [8]. Baaj and Mahmassani's approach was an AI-based solution approach which consisted of three major components; a route generation algorithm (RGA), an analysis procedure TRUST (transit route analyst) and a route improvement algorithm [9]. A nonlinear mixed integer programming model was proposed by Ceder and Israeli that minimized the generalized cost and fleet size as a two-level objective function [10]. Pattnaik, Mohan and Tom used a genetic algorithm to solve the urban bus route network design problem through an optimization problem with the objective of minimizing the overall system cost [11]. Tom and Mohan improved Pattnaik's approach with a new genetic coding [12]. Genetic algorithm was also used by Chakroborty and Wivedi for bus network design [13]. Ngamchai and Lovell's procedure had three main stages; a route generation, route evaluation and route improvement. The GA was employed to solve the proposed model [14]. The objective function of Zhao and Gan was to minimize the number of transfers in the network and maximize route directions. The studied algorithms by both greedy and tabu were used to solve this model [15]. Fan and Machemehl solved bus planning problem with a variety of metaheuristics algorithms (genetic,

local search, random search, simulated annealing and tabu) and revealed that genetic algorithms were more efficient for large scale bus network design problems [2]. Han et al. proposed a two level model and applied genetic, tabu and simulated annealing algorithms. Their suggested model did not generate more reasonable results compared with the previous models [16]. Zhao suggested a simulated annealing approach for the minimization of the passenger' cost [17]. Zhao and Zeng utilized a combination of simulated annealing, tabu and greedy algorithms to minimize users' cost [18].

It could be concluded from this section that the objective function of most of the previous studies included two main terms; user and operator costs. Most of them used total travel time of passengers as the user cost including waiting time, running time and a panelized transfer time. Total bus-kilometer or bus-hour together with the number of buses were employed to reflect operator cost. The constraints frequently used in the previous studies included frequency feasibility, load factor constraint and fleet size constraint.

3. Mathematical Formulation

The objective function in this study was similar to the previous ones; however, it had the following differences:

1. This formulation included depots assignment term that guaranteed the optimal assignment of buses to depots.

2. It included a penalty for empty seats which optimized fleet's capacity.

3. The presented model assumed a penalty for unmet demand which improved network's reliability from users' perspective.

Although the last two objectives have been further used in the previous studies, none have considered them simultaneously.

The proposed formulation included two main parts; user's and operator's overall costs. The first term of equation (1) presented user's costs and the second term presented operator's costs. The objective function and constraints are presented in Equations (1) to (10).

$$\min z = c_1 \sum_{i,j \in N} fP(i, j) + c_2 \sum_{i,j \in N} fO(i, j) \quad (1)$$

$$\sum_{i,j \in N} fP(i, j) = \sum_{r \in R} \sum_{i,j,k \in N} [d_{ij} \cdot (t_{ij}^{wait} + t_{ij}^{run} + t_{ij}^{transfer})] + c_3 \cdot \sum_{r \in R} \sum_{i,j \in N} \bar{d}_{ij} \cdot t_{design} \quad (2)$$

$$\sum_{i,j \in N} fO(i, j) = c_4 \sum_{r \in R} \sum_{i,j,k \in N_r} \lambda_k \cdot T_k + \sum_{k \in N_r} \left(\lambda_k \cdot CAP - \sum_{i,j \in N} d_{ij} \right) \quad (3)$$

$$c_4 = 1 + \left(\frac{\sum n_d \cdot t_{depot}}{\sum t_{ij}} \right)_k \quad (4)$$

$$\lambda_k \geq \lambda_{min} \quad (5)$$

$$(lf_{min} \leq lf \leq lf_{max}) \quad (6)$$

$$t_{depot} \leq t_{dmax} \quad (7)$$

$$\sum_k \lambda_k \cdot t_k \leq N_f \quad (8)$$

$$M \leq R_{max} \quad (9)$$

$$t_{min} \leq t_{ij} \leq t_{max} \quad (10)$$

In these equations:

$fp(i,j)$: Passengers' cost function

$fo(i,j)$: Operator' cost function

d_{ij} : Demand from node i to j

t_{ij}^{wait} : Waiting time that each passenger experiences which is calculated from the headway of each route: $t_{ij}^{wait} = \lambda_k/2$

t_{ij}^{run} : In-vehicle travel time from node i to j

$t_{ij}^{transfer}$: Transfer time from i to j ; which is equal to the sum of the penalty time (5 minutes) and waiting time for the arrival of the next route bus

D_{ij} : Unsatisfied demand

t_{design} : Total design time; in other words, the analysis period (60 min)

λ_k : Headway of route k

T_k : Round trip time of route k

CAP : Bus capacity.

n_d : Number of each bus dead-head trip per day

t_{depot} : Travel time from each terminal to depot

t_{ij} : Total travel time from node i to j

c_1, c_2, c_3, c_4 : Coefficients that represent passenger cost, operator cost, unsatisfied demand, depot and dead-head trips weights

N : number of OD pairs (i,j)

N_r : route collection in network (i,j)

In this objective function, $fp(i,j)$ reflects user's cost that includes waiting time plus running and transfer time that each passenger experiences in the bus network. In addition, it includes a parameter that presents unsatisfied demand cost.

Operator's cost function is represented by $fo(i,j)$ which includes total travel time cost, dead-head trip costs and empty seat costs. c_1 and c_2 are coefficients that present weight of user and operator cost, respectively. The constraints of the model are:

- Maximum headway for each route which is the policy headway and is exogenous to the model.
- Lower and upper bounds for load factor which balances the number of passengers for each bus and prevents from overcrowding or running empty.
- Maximum travel time to depot, which prevents from large dead-head times.
- Maximum number of fleets which reflects constraints of bus' company.
- Minimum and maximum route travel time which prevents from the generation of very short or very long routes.
- Maximum number of routes which prevents from the number of routes; therefore, operator costs will increase.

4. Solution Methodology

In this section the suggested methodology to solve bus network design will be presented. It has three main steps. The first step is the route generation algorithm. In this step all possible routes will be generated; subsequently, the suggested networks will be selected from allowable routes (routes that comply with the constraints). The Genetic Algorithms (GA) will be utilized for bus network selection. In the second step

passengers and buses will be assigned to the network which is generated in the Network Design Procedure (NDP). In this stage frequencies are set. With the completion of the Frequency Determination and Assignment Procedure (FDAP), network parameters such as total travel time, number of direct trips, fleets size will be calculated. Evaluation of each network, base on its fitness function will be accomplished in the third step or in the Network Evaluation Procedure (NEP). Finally, the best network will be selected by comparing the fitness function of all networks. Figure (1) illustrates the flowchart of the presented model. One of the important differences between this methodology and the previous ones is the determination of the number of routes. This model can optimized and determine the number of route for a network. In the previous studies the number of routes was primarily determined and afterwards the best network was selected. however in the suggested methodology, the number of routes is a one of the decision variables and is determined within the optimization process. In subsequent sections each step of suggested methodology will be presented.

4.1 Network Design Procedure (NDP)

The first step in bus planning process is route generation algorithm. This algorithm includes two sub algorithms: the identification of possible routes and the selection of allowable networks. In the first sub algorithm, based on network data such as demand matrix and travel time matrix, primary paths

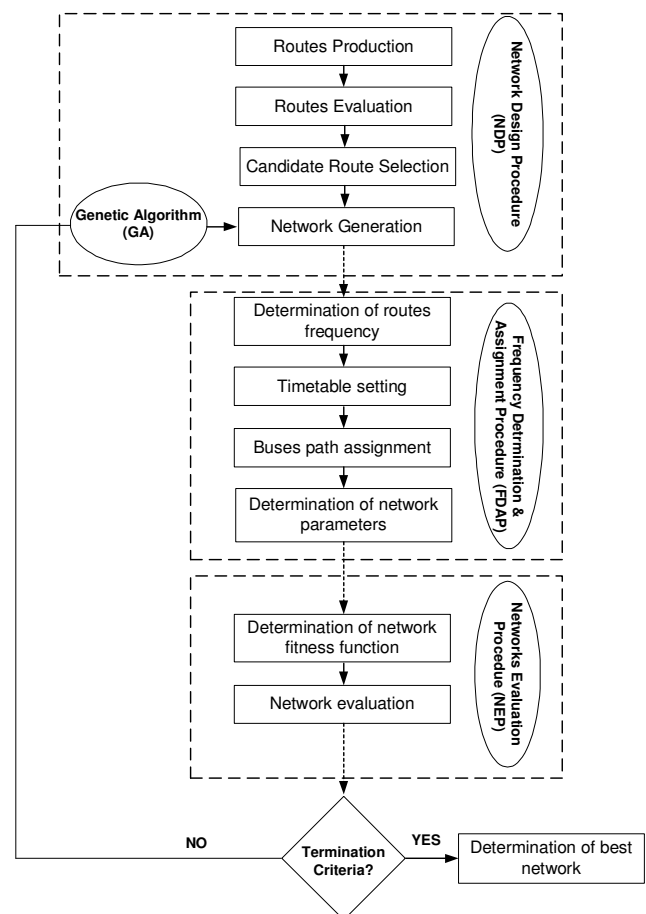

Fig.1 Flowchart of the solution methodology

will be produced. In the next sub algorithm allowable routes are determined. Selection of allowable routes is according to the following process; first, the shortest paths between all origins-destinations will be determined, afterwards paths with lengths within a desirable limit (usually paths with travel time up to 1.2 shortest paths) will be selected as initial paths. To change initial paths to allowable routes two other conditions are examined:

- 1- Minimum length of routes; to prevent very short routes.
- 2- Maximum length of routes; to prevent very long routes.

To generate shortest paths between all nodes, Floyd Warshall algorithm has been employed. For this model Floyd Warshall algorithm performs more satisfactory compared to Dijkstra's because it can generate the entire shortest path in a single run. The shortest paths between all nodes have been primarily generated. A stopping criterion has been employed to decrease the calculation time. When the travel time of routes have exceeded 1.2 times the shortest path time, the searching process of the route has been stopped and another route was examined. Allowable route generation process is displayed in Figure (2).

After generating allowable routes, the networks are formed with the GA by combining the routes previously generated. Figure (3) illustrates the network generation algorithm which has been applied in this article.

More approach will be used for route generation such as simulated annealing. Simulated annealing's roots are in thermodynamics, where one studies a system's thermal energy [19]. In this research we used genetic algorithms for route generation process. In nature, different kinds of creatures exist. The differences appear in the chromosomes of the creatures and thence results diversity in their structure and behavior, which affects their procreation [20]. The network generation process is as follows; first, a string with n genes will be produced which n is equal to the number of allowable routes. This string is a binary one. A gene with the value of one indicates that the route related to that gene is included in the network and a gene with a zero value means that the route does not exist in the network. The primary population of the GA depends on the size of the city and designers experience and will be randomly produced. Each string presents a bus

network. In this step, genetic operations will be executed and will change the base networks. After producing each network, its fitness function will be determined (in NEP). If the functional parameters of the network improve (by checking all the parameters calculated in FDAP), then it will be more likely that this network will be applied in the next GA run. Therefore the GA can find more efficient and better networks and will finally end up with the optimum or near optimum network. Genetic operators which will be used in this process include; reproduction, cross over and mutation. Figure (4) illustrates the network coding with genetic algorithm and operator's actions. The network N1 at this figure presents the network with routes 2, 4, 5, 7, 10. Two kind of cross over operators will be exploited at this coding process; Single-Sight cross over and Two-Point cross over which are illustrated in figure (4). After network generation, the maximum number of routes will be controlled and if it exceeds the allowable number of routes, the network will be deleted.

4.2 Frequency determination and Assignment Procedure (FDAP)

In this step, functional parameters of each network (networks produced in the NDP) are calculated. To calculate these parameters for each network, route frequencies should be set and buses should be assigned to the routes of the network. In the first stage, bus frequencies are determined; next, timetabling and bus assignment to routes and depots are performed.

Ceder described four methods to calculate frequencies. Two were based on point check and two on ride-check. Point-check methods counted the passengers on board of the transit vehicle at certain points whereas ride-check methods counted the passengers along the entire transit route.

In the point-check methods, frequency is the ratio of the passenger load at the maximum load point to the desired occupancy of the buses. Ceder distinguishes between the load for the whole day and the load in each period. These methods are called the daily max load methods and the period max load methods, respectively. In this study, the period max load method was used.

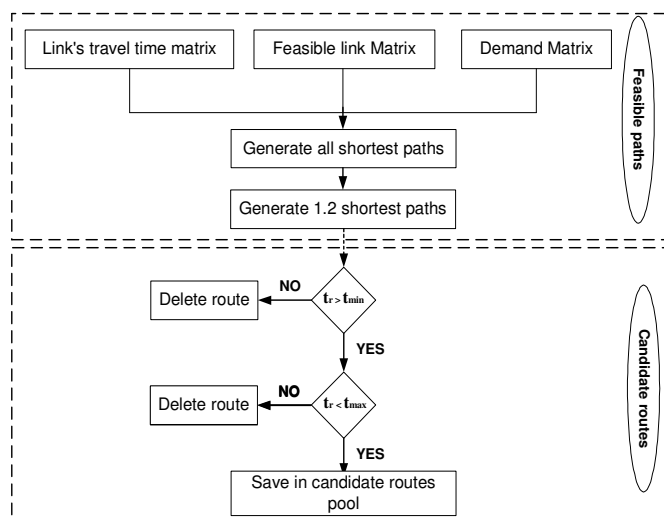

Fig. 2 Flowchart of allowable route generation

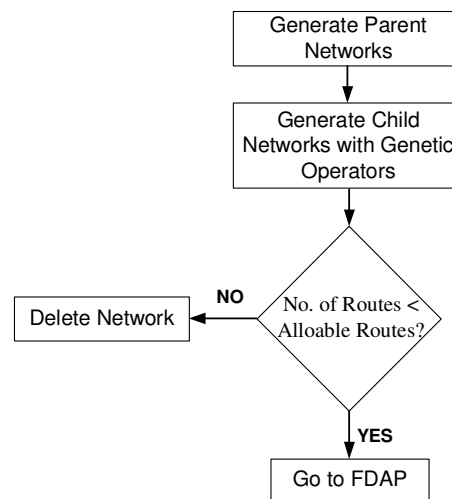

Fig. 3 Flowchart of Network Design Procedure (NDP)

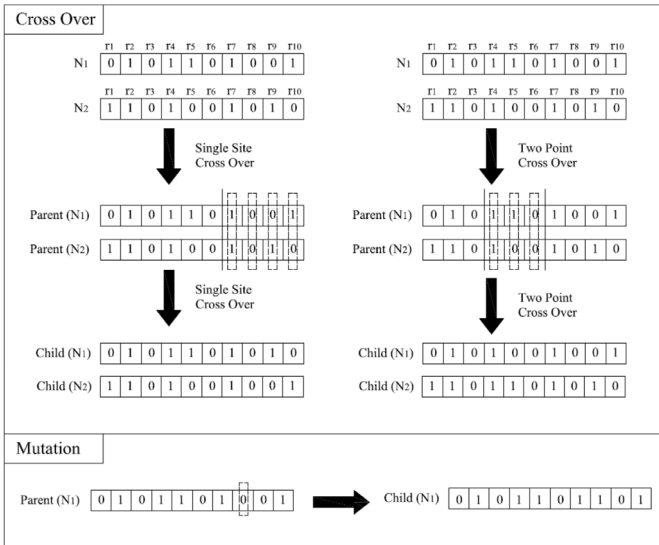

Fig. 4 Network coding and genetic operator

As suggested by its name, the period max load method does not consider the daily max load point, rather the period max load point. The advantage of this approach is that the load does not exceed the desired occupancy in any segment of the line. On the contrary, the frequency is (non-strictly) higher compared with the case of the daily max load method. The mathematical formulation of the period max load method is [21]:

$$\lambda_r = \frac{D_r}{lf \cdot Seat} \quad (11)$$

where D_r is the maximum demand between all nodes of route r ; in other words, it is the demand of most of the crowded segments of the route. Other parameters were described in the preceding sections. In this article, Ceder's approach was used to determine the frequencies.

In this research, a utility model was employed for passenger assignment to routes or transit assignment. First, the number of buses per route was determined according to demand and headway constraints. Subsequently, passengers were assigned to routes. Where parallel paths existed between origin and destination, passenger assignment to routes was according to the travel time utility. Equation (12) was applied to calculate the utility of each route. Moreover, the Logit model was used to define utility function. It was further assumed that passengers primarily selected direct routes. If there were direct routes between an OD pair, they would be selected first.

$$u_r = \frac{e^{-t_r}}{\sum e^{-t_r}} \quad (12)$$

where t_r is the total travel time by route r . The flowchart of frequency setting and transit assignment is demonstrated in Figure (5). It is worth mentioning that the FDAP was in fact an iterative procedure. First, the minimum frequency was used for each route; afterwards, passengers were assigned to the routes based on their frequencies and travel times. In the second iteration, the frequencies were updated based on the assigned demand and passengers were reassigned until the convergence of the calculated frequencies.

4.3 Network Evaluation Procedure (NEP)

In this step, each of the previously generated networks was evaluated base on their functional parameters. The fitness function was calculated for each network based on the outputs of the FDAP and was saved. On the other hand, these outputs were utilized as the input to genetic operators. It is worthwhile to mention that the objective function was a combination of two terms; user cost and operator cost; thus, the networks with minimum total cost were selected as the optimum network.

5. Result of the Testing Model

This section presents the results obtained by applying the proposed model to a hypothetical network. To highlight the efficiency of the proposed algorithm, it was applied to a network which was used earlier by several authors in order to test their route design algorithms (as shown in Figure 6). This network was primarily used by Mandl [5] and later used by Baaj and Mahmassani [9], Chakroborty [13], Han et al. [16] and Zhao et al. [17], [18]. Furthermore, Figure 6 shows the bus network proposed by Mandl.

First, the result of the presented model on the base network was presented for a comparison; afterwards, the model was applied to the network with the two assumed depots since Mandl's network did not have any depots.

Although the matrix was not reproduced here, it can be pointed out that the total transit demand was 15570 trips per day and the same OD matrix utilized in other studies was applied in this research, too. Table (1) displays the assumed

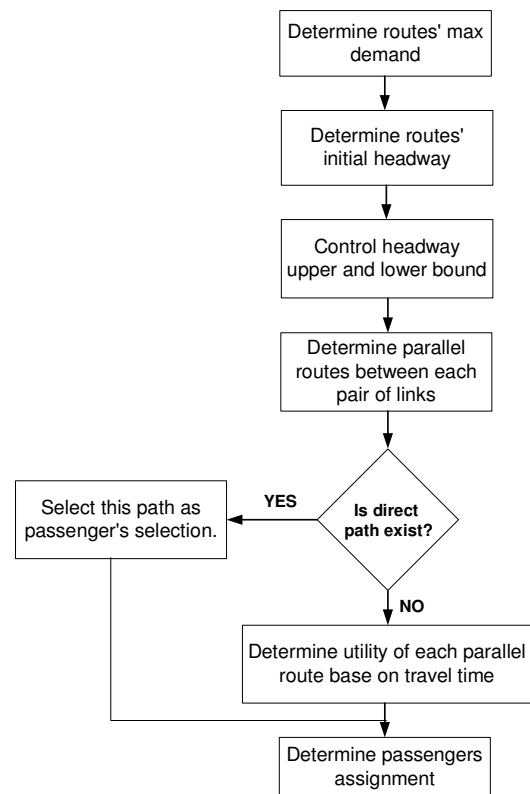

Fig. 5 Flowchart of Frequency Determination and Assignment Procedure (FDAP)

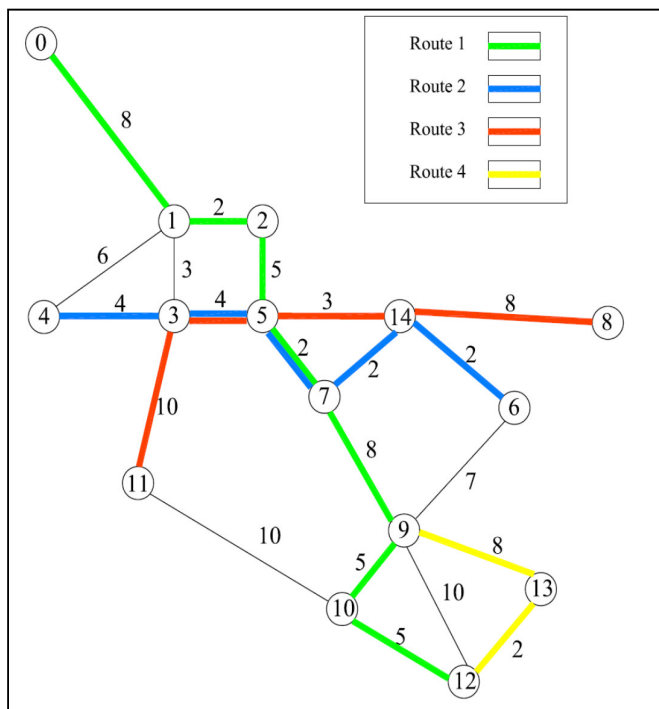

Fig. 6 Mandl's benchmark network

travel time for each node to depots and Figure 6 shows the travel time of each link in the network.

It is expected that the suggested model will perform more satisfactory compared with the previous model due to the fact that:

- 1- It can optimize bus assignment to depot.
- 2- It can optimize the number of routes (in the previous studies, the number of routes was predetermined).
- 3- It can minimize unsatisfied demand and empty seats of buses.

The results for the suggested model are illustrated in Table (2). In this table, the results of the suggested model are shown along with the results of previous studies. It is worth stating that the assumptions of this study were similar to those of others;

- Transfer penalty for each transfer = 5min
- Number of seats per bus = 40
- Maximum load factor = 1.25

According to Table (2), the suggested model had more reasonable result compared with other models for the following parameters: total travel time, transfer time and number of bus fleets. Only transferred passengers were higher in the suggested model. As achieved by this model, the least total travel time with the least number of fleet had the lowest

Table 1 Assumed travel time of each node to depot

Node	1	2	3	4	5	6	7	8	9	10	11	12	13	14
Depot1	0	0	2	0	0	0	0	0	5	0	0	0	0	0
Depot2	0	0	0	0	0	0	0	3	0	0	0	3	0	0

Table 2 Result of the suggested model and previous studies

Author	No. of routes	Total travel time	In-vehicle time	Waiting time	Transfer time	No. of fleets	Unsatisfied demand %	Direct passenger %	Transfer passenger %
Mandl1979	4	219094	177400	18144	23500	100	69.94	29.93	
	6	205656	168076	20930	16650	90	78.61	21.39	
Baaj, Mahmassani 1997	217869	180350	27719	14800	83	80.99	19.01		
	8	210632	169101	25931	15600	77	79.96	20.04	
Chakroorty, Wivedi 2002	4	202110	NR	NR	NR	NR	0	86.86	13.14
	6	174946	NR	NR	NR	NR	0	86.04	13.96
	7	172398	NR	NR	NR	NR	0	89.15	10.85
	8	177630	NR	NR	NR	NR	0	90.38	9.58
	4	NR	NR	NR	NR	NR	0	75.72	24.28
Zhao, Gan 2003	6	NR	NR	NR	NR	NR	0	89.15	10.85
	7	NR	NR	NR	NR	NR	0	84.84	15.16
	8	NR	NR	NR	NR	NR	0	90.75	9.25
Han, Lee, Kim 2005	9	195287	NR	NR	NR	200	0	92.61	7.39
	4	185158	NR	NR	NR	NR	0	95.31	4.69
Zhao 2006	6	190998	NR	NR	NR	NR	0	95.18	4.82
	7	190478	NR	NR	NR	NR	0	92.49	7.51
	8	195466	NR	NR	NR	200	0	95.44	4.56
	4	181957	NR	NR	NR	NR	0	96.66	3.34
Zhao, Zeng 2008	6	182258	NR	NR	NR	NR	0	98.39	1.61
	7	189854	NR	NR	NR	NR	0	94.54	5.46
	8	187984	NR	NR	NR	NR	0	95.83	4.14
results of Mandl network	6	171629	140829	19436	11364	60	88.75	11.25	
Suggested model Mandl plus depots	6	178358	144167	22126	12065	60	86.55	13.45	

operator cost compared with all other models. Figure (7) indicates the results of all models which have been applied on Mandl's network. As shown in this figure, the least number of buses and total travel time were achieved by the proposed methodology. Therefore, in this study, the best network was resulted by the methodology presented from user and operator's perspectives.

In Figure (8), all the results achieved by Mandl, Baaj and the proposed model are illustrated in a graph. Since other studies have not presented a number of parameters such as number of fleets or in-vehicle time, a full diagram could not be drawn. As could be seen in Figure (8), the minimum number of fleets and minimum value of total travel time were achieved by the proposed model. Meanwhile, the percent of direct trips in the proposed model was higher compared with the models presented by Mandl and Baaj. It is worth mentioning that a number models such as Zhao (2006) and Zhao and Zeng (2008) could approximately handle all the passengers with direct trips; however, they did not declare the number of fleets and the total travel time achieved by their model. In realistic networks, it is probably impossible to serve all trips directly; hence, networks with less travel time and number of fleets are more desirable for both bus operator and users.

6. Sensitivity Analysis

In this section, sensitivity analysis was performed to determine the best value of the GA parameters, number of iterations and number of first population.

The number of iterations increased from 10 to 100 and the population of chromosomes changed from 10 to 50. The objective function was determined for different values of these parameters and their combination for the test network. The results are shown in Figure (9), in which the value of the objective function was mirrored for convenience. As could be seen in this figure, the value of the objective function was improved by increasing the number of iterations and populations. The best value of Z (objective function) was generated with 50 iterations and 40 chromosomes. Calculation time was another important parameter which can play a significant role in large scale networks. As illustrated in Figure (10), the calculation time increased by increasing the number of iterations and chromosomes; however, it was less than three minutes in all the cases. Calculation time was more sensitive to the iteration number than number of chromosomes.

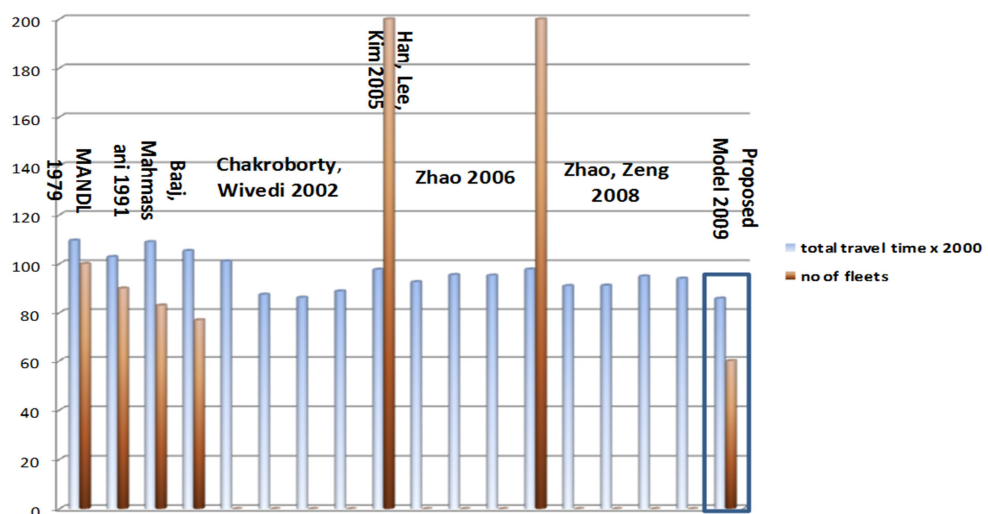

Fig. 7 Comparison between different models for solving Mandl network

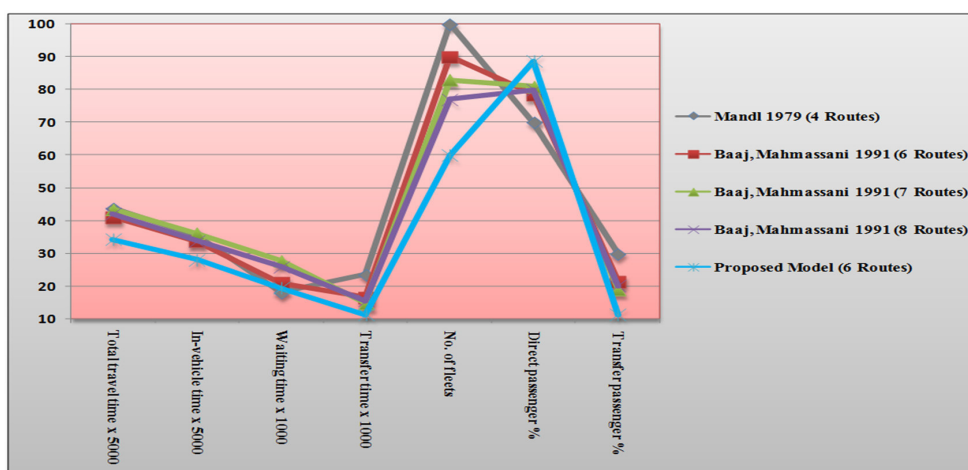

Fig. 8 Comparison between models for solving Mandl network

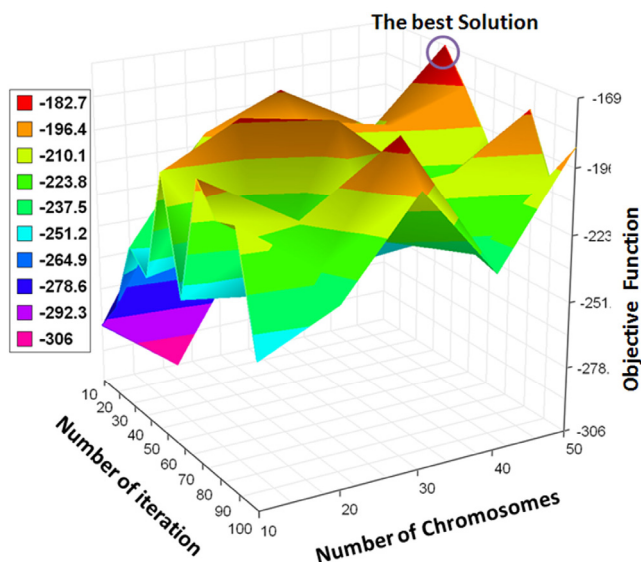

Fig. 9 Sensitivity analysis of GA parameters

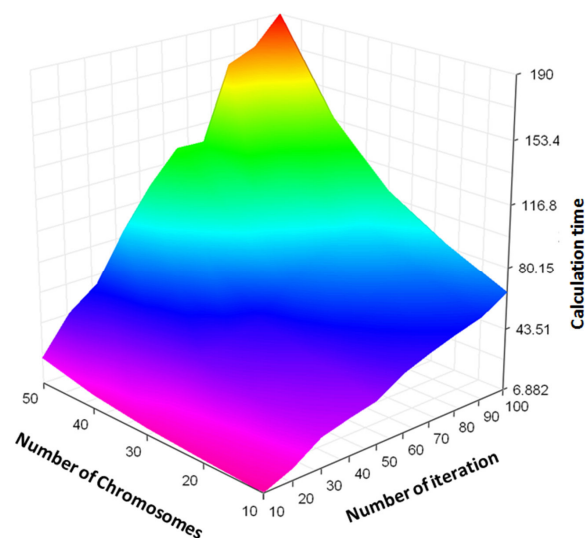

Fig. 10 Calculation time changing against variation of GA parameters

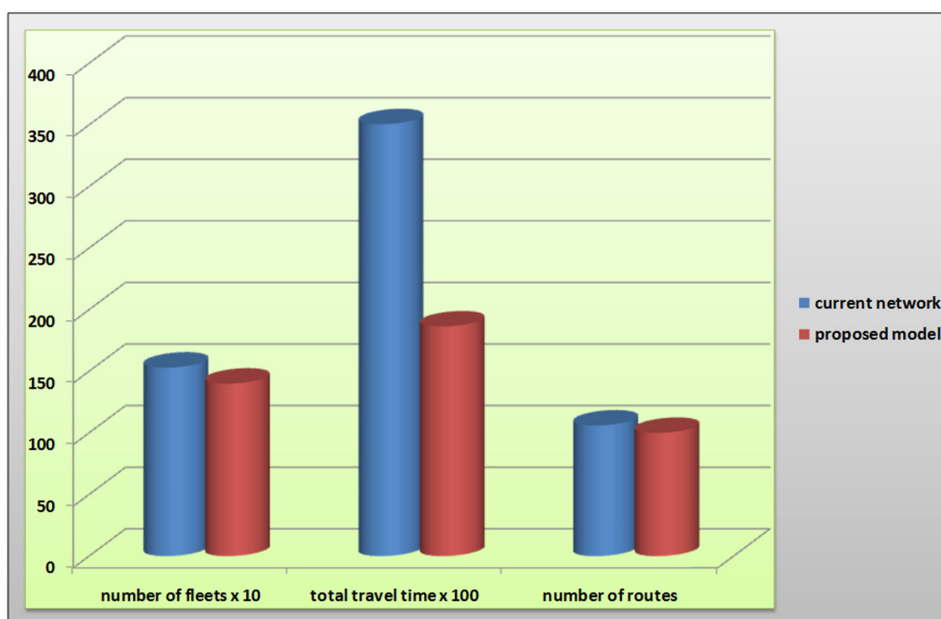

Fig. 11 Comparison of the proposed model versus the current network

7. Case Study

After evaluating the presented model on Mandl's network, the proposed model was applied to city of Mashhad network. Mashhad was the second biggest metropolitan in Iran. The population of Mashhad is about 2868350. Other characteristics of this city were shown in Table (3).

The current configuration of Mashhad's bus network is given in Figure (12). The results of the proposed model are shown in Table

(4). According to this table, the total number of fleets reduced by about 9% while total travel time of the network decreased by about 45%. These results are demonstrated in Figure (11). Finally, in Figure (13), the proposed network for Mashhad is illustrated.

8. Conclusion

In this paper, a model was presented which was proven to be superior to previous models for bus network design with the

Table 3 Mashhad characteristics

City area	Bus travel passengers per year	Total network length	Number of bus routes	Number of bus fleets	Average speed	Total travel time
195 km ²	380 million	1335 km	106	1530	17.5 km/h	35059 p.h



Fig. 12 Current bus network of Mashhad city



Fig. 13 The proposed bus network of Mashhad city

Table 4 Results of the proposed model

Network	Number of bus routes	Number of fleets	Total
current situation	106	1530	35059
Proposed model	100	1400	18631
Improvement	6%	8.5%	46.5%

objective of optimizing the overall system costs including user and operator costs. The model considered both the operator point of view, which aimed to optimize total travel time and number of bus fleets, and the passengers' objective to minimize the total travel time including waiting time, running

time and transfer time. The suggested model was tested on Mandl's network that has been previously tested by other authors. The result of the suggested model was more satisfactory compared with that of the previous studies in a number of parameters, i.e. waiting time, running time, transfer time and number of buses which operate in the system. Sensitivity analysis was conducted to determine the optimum number of iterations and population. Calculation time of the proposed model was within a desirable range. Finally, the model was applied to the city of Mashhad and the results indicated highly effective improvement in terms of travel time and fleet size.

References

- [1] Transportation Research-B, 1986, Bus Network Design, Vol. 20B, No 4. PP 331-344, 1986.
- [2] Fan, W., Machemehl, R.B., "Optimal Transit Route Network Design Problem: Algorithms, Implementations, and Numerical Results", Research Report SWUTC/04/167244-1, Southwest Region University Transportation Center for Transportation Research University of Texas at Austin, 2004.
- [3] Lampkin, W. and Saalmans. P.D., "The Design of Routes, Service Frequencies and Schedules for a Municipal Bus Undertaking: A Case Study", Operation Research Quarterly, No. 18, pp. 375-397, 1967.
- [4] Silman, L.A., Barzily, Z., and Passy, U. "Planning the Route System for Urban Buses", Computers and Operations Research, Vol. 1, pp 201-211, 1974.
- [5] Mandl, C.E., "Evaluation and Optimization of Urban Public Transport Networks", European Journal of Operational Research, Vol. 6, pp 31-56, 1980.
- [6] Dubois, D., Bell, G., and Llibre, M., "A Set of Methods in Transportation Network Synthesis and Analysis", Journal of Operations Research Society, Vol. 30, pp797-808, 1979.
- [7] LeBlanc. L.J., "Transit System Network Design", Transportation Research Part B, Vol. 22, No. 5, pp 383-390, 1988.
- [8] Van Nes, R., Hamerslag, R., and Immer, B.H., "The Design of Public Transport Networks", Transportation Research Record, No. 1202, Transportation Research Board, Washington, D.C., pp 74-83, 1988.
- [9] Baaj, M.H. and Mahmassani, H.S., "An AI-Based Approach for Transit Route System Planning and Design", Journal of Advanced Transportation, Vol. 25, No. 2, pp 187-210, 1991.
- [10] Ceder, A, Israeli, Y., "User and Operator Perspectives in Transit Network Design", Transportation Research Record, No. 1623, 1998.
- [11] Pattnaik, S.B., Mohan, S. and Tom, V.M, "Urban Bus Transit Network Design Using Genetic Algorithm", Journal of Transportation Engineering, Vol. 124, No. 4, pp 368-375, 1998.
- [12] Tom, V.M. and Mohan, S., "Transit Route Network Design Using Frequency Coded Genetic Algorithm", Journal of Transportation Engineering, Vol. 129, No. 2, pp 186-195, 2003.
- [13] Chakroborty, P., Wivedi, T., "Optimal route network design for transit system using genetic algorithms", Journal of Engineering Optimization, Vol. 34(1), pp.83-100, 2002.
- [14] Ngamchai, S. and Lovell, D.J., "Optimal Time Transfer in Bus Transit Route Network Design using a Genetic Algorithm," ASCE Journal of Transportation Engineering, Vol. 129, No. 5, P 510-521, 2003.
- [15] Zhao, F., Gan, A., "Optimization of Transit Network to Minimize Transfers", Final Report BD015-02, Research Office Florida Department of Transportation, 2003.
- [16] Han, J., Lee, S., Kim, J., "Meta-Heuristic Algorithms for a Transit Route Design", 16th Mini-EURO Conference, Artificial Intelligence in Transportation, September 13-16, 2005, Poznan, Poland, 2005.
- [17] Zhao, F., "Large-Scale Transit Network Optimization by Minimizing User Cost and Transfers", Journal of Public Transportation, Vol. 9, No. 2, 2006, pp 107-129, 2006.
- [18] Zhao, F., Zeng, X., "Optimization of transit route network, vehicle headways and timetables for large-scale transit networks", European Journal of Operational Research, Vol. 186, pp 841-855, 2008.
- [19] Sh. Afandizadeh, S. A. H Zahabi, N. Kalantari, "Estimating the parameters of Logit Model using simulated annealing algorithm: case study of mode choice modeling of Isfahan", International Journal of Civil Engineering. Vol. 8, No. 1, March 2010.
- [20] [Sh. Afandizadeh, Reza Taromi, "Selecting an Optimum Configuration of Urban One-Way and Two-Way Streets Using Genetic Algorithms", International Journal of Civil Engineering, Vol. 4, No. 3, September 2006.
- [21] Ceder, A., Methods for creating bus timetables, Transportation Research, Vol. 21A, No. 1, pp. 59-83, 1986.