

## Experimental study of geotextile's drainage and filtration properties under different hydraulic gradients and confining pressures

Ali Pak\*, Zahra Zahmatkesh

Received: March 2009, Revised: July, 2010, Accepted: October 2010

### Abstract

Geotextiles are one of the most widely used synthetic materials in filtration and drainage applications. Since in real applications, geotextiles are subjected to various hydraulic gradients and confining stresses, hydraulic behavior of geotextiles under different circumstances is of great practical importance. In this study filtration and drainage properties of several nonwoven needle-punched geotextiles with different properties and unit mass per area of 200g/m<sup>2</sup>, 400g/m<sup>2</sup>, 500g/m<sup>2</sup> and 800g/m<sup>2</sup>, under various confining stresses and hydraulic gradients, were studied using standard permittivity and transmissivity equipments. Prepared samples were subjected to hydraulic heads in the range of 10cm to 60cm and confining stresses up to 1000kPa and their hydraulic behavior was investigated accordingly. In this study the flow regime through the geotextile fibers and also the anisotropic behavior of geotextile permeability were investigated. The results show that transmissivity will decrease exponentially with increasing the normal stress until a residual value is reached, and permittivity and transmissivity coefficients were seen to decrease with increasing the hydraulic gradient. The flow regime has found to be non-turbulent in all cases. The Geotextile hydraulic behavior is of great usage in the design of landfill covers, design of embankments and irrigation structures drainage systems, and in the design of protection systems in river engineering.

*Key words:* Nonwoven geotextile, Normal stress, Hydraulic gradient, Transmissivity, Permittivity

### 1. Introduction

Soil in situ behavior is so sensitive to its properties and material used in its structure. Different synthetic materials are used to change and enhance the natural behavior of soil regarding to different practical purposes. Because of the importance of soil and in used materials' behavior, some investigators have examined the soil behavior under synthetic materials effects from different aspects. Abdi et al., [1] and [2], conducted experimental programs to determine the effects of geosynthetics on soil properties. Nayeri and Fakharian, [3], studied pullout behavior of some kinds of geosynthetics.

Geotextiles are among the most widely used synthetic materials to improve the soil hydraulic properties from filtration and drainage aspects. Since geotextiles are exposed

to different stresses and hydraulic gradients in the field, their hydraulic behavior in real situations is important. Several experimental techniques can be used for investigation of hydraulic behavior of geotextiles. Two of these techniques are transmissivity (water permeability in the plane of the geotextile) and permittivity (water permeability perpendicular to the surface of the geotextile) tests that were used in this study for conducting the experiments.

Since geotextiles have the capability of water transmission parallel and perpendicular to their plane, assessing and measuring their hydraulic properties in two perpendicular directions are necessary for practical purposes.

Determination of geotextile transmissivity, in all applications that flow exists in the geotextile plane, is desirable. This geotextile property was originally investigated by Leflaive and Puig [4]. Before that, mostly the property of fluid conduction perpendicular to the plane was considered.

Sankey and Koerner, [5], Koerner, et al, [6], Adolphe, et al, [7], El-Gamal, et al, [8], Jeon, et al, [9], and Narejo, [10], have

\* Corresponding Author: pak@sharif.edu  
Civil Engineering Department, Sharif University of Technology,  
Tehran, Iran

carried out some experiments on the in-plane hydraulic behavior of geotextiles. While van der Sluys and Dierickx, [11], and Aydilek and Kutay, [12], have investigated normal to the plane hydraulic properties of geotextile.

Kellner and Ionescu, [13], Gardoni and Palmeira, [14], and Hufenus and Schrade, [15], have studied some hydraulic properties of geotextiles in-plane and normal to the plane under different hydraulic properties.

The most effective parameters in hydraulic behavior of geotextiles are porosity, pore size, and pore size distribution, which are strongly dependent on their production technology.

The geotextile hydraulic behavior is of great usage in the design of landfill covers; design of embankments and irrigation structures drainage systems, and in the design of protection systems in river engineering.

The purpose of this research is investigation of mechanical and hydraulic properties of needle punched nonwoven geotextiles under different hydraulic gradients and various confining stresses up to 1000kPa. The investigated properties are permittivity, transmissivity, porosity and thickness. Experimental methods that were used in the present work have been permittivity and transmissivity tests apparatus

## 2. Equipments and materials

### 2.1. Equipments

Transmissivity tests were performed using an apparatus that was designed and developed based on ASTM D 4716. The schematic view of the equipment is presented in Fig. 1. This apparatus is capable of measuring the in-plane hydraulic conductivity of geotextiles under confinements up to 1000kPa. The geotextile specimens' dimensions were 200×100 mm and were subjected to the normal stress applied by a rigid polyamid plate. The variation of the geotextile thickness with normal stress can be obtained, as a function of the vertical displacement of the rigid plate which was calculated as the average of the readings from displacement transducers positioned at two different locations on the plate. In each normal stress the transmissivity was measured under hydraulic gradients of 0.5, 1, and 3.

To measure normal to the plane hydraulic conductivity of geotextile, the equipment that is shown in Fig. 2, was used. This equipment was designed and developed based on the scheme recommended in ASTM D 5493. The equipment is capable of performing permittivity tests under normal stresses up to 300 kPa. In each normal stress the permittivity

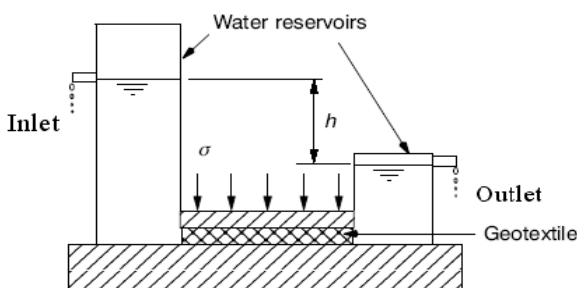

Fig. 1. Schematic side view of the transmissivity test equipment

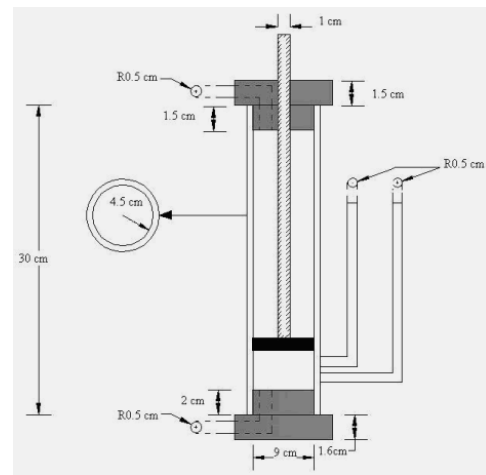

Fig. 2. Permittivity test equipment

was measured under certain hydraulic heads between 10cm to 60cm. A steel piston applies the normal load to a rigid polyamid loading plate on a 90 mm diameter geotextile specimen, confined between two sets of steel meshes, with open area of 36%. The meshes serve as permeable media that help to distribute the normal stress on the geotextile uniformly.

### 2.2. Geotextile materials

As mentioned, the aim of this work is investigation of in-plane and normal to the plane permeability of geotextile. Since only some of the geotextiles are capable of transmitting liquid in their plane, four non-woven needle punched geotextiles from three companies were selected for testing. This capability is because of their sufficient thickness and good pore structure [6].

The main characteristics of these geotextiles are presented in Table I. The mass per unit area of the geotextiles varies from 200 to 800 g/m<sup>2</sup>, covering the range of geotextile mass per unit area values that are often used in practice [14].

## 3. Test results

### 3.1. Results of transmissivity tests

During the transmissivity tests for each normal stress and hydraulic gradient, the quantity of the water that passed through the specimen over a specific time period, was

Table 1. Physical characteristics of the soils

Geotextile	8.IG	5.BN	4.IG	2.MS
Mass per unit area(g/m <sup>2</sup> )	800	500	400	200
Polymer Type	PPa	PP	PP	PESb
Thickness (mm)	6.6	3.8	3.5	0.8
AOSc (mm)	0.07	0.15	0.09	0.25
Diameter of fibres (mm)	0.0483	0.043	0.043	0.0268
Porosity	0.867	0.854	0.874	0.819

<sup>a</sup>Polypropylene, <sup>b</sup>Polyester, <sup>c</sup>Apparent Opening Size

recorded. This measurement was repeated at least three times for each selected hydraulic gradient. Then the transmissivity is calculated based on Equation 1 as follows:

$$\theta = (QL) / (Wh) \quad (1)$$

Where  $\theta$  is hydraulic transmissivity (cm<sup>2</sup>/s), Q is the average quantity of fluid discharged per unit time (cm<sup>3</sup>/s), L is length of the specimen (cm), W is width of the specimen (cm) and h is difference in total head across the specimen (cm). Since transmissivity values are affected by the temperature of the water [13], according to ASTM D 4716 hydraulic transmissivity of the geotextiles are corrected for 20°C by multiplying the hydraulic transmissivity by the ratio of the viscosity of water at test temperature to the viscosity of water at 20°C. Variation of transmissivity in various gradients under different normal stresses is plotted in Figs. 3-6. As presented in Figs. 3-6, the geotextile transmissivity under high stress levels can be reduced up to 2 to 3 orders of magnitude, depending on geotextile thickness. Under each constant normal stress the

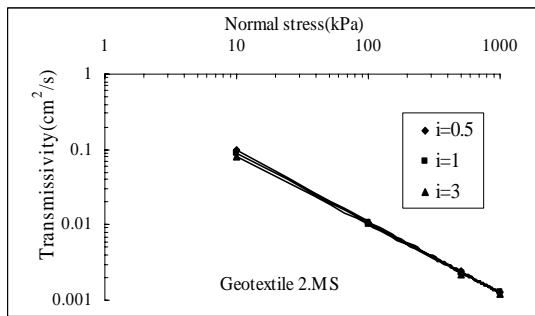

Fig. 3. Results of transmissivity tests for geotextile 2.MS

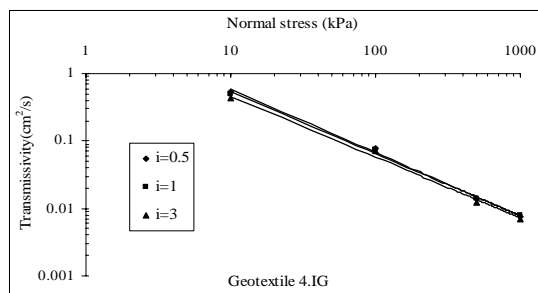

Fig. 4. Results of transmissivity tests for geotextile 4.IG

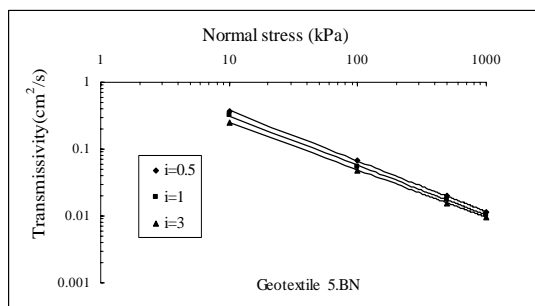

Fig. 5. Results of transmissivity tests for geotextile 5.BN

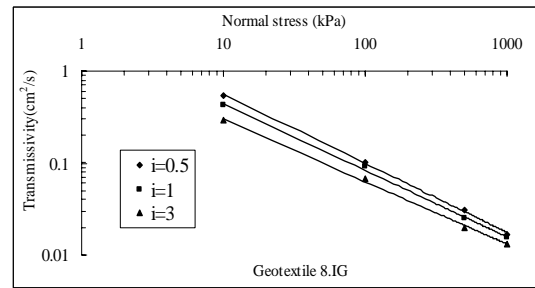

Fig. 6. Results of transmissivity tests for geotextile 8.IG

transmissivity decreases with increasing the hydraulic gradient. The results in each figure also show that the sensitivity of in-plane permeability of geotextiles with respect to the applied stress level gradually decreases. Comparing these four figures with each other demonstrates that the influence of hydraulic gradient on the transmissivity becomes more pronounced when mass per unit area (thickness) of geotextile is greater.

Variation of the transmissivity ratios in minimum and maximum applied normal stresses for all specimens are presented in Table 2. As it is given in Table II, the ratio of  $\theta_{10}/\theta_1$  decreases with increasing hydraulic gradient and geotextile thicknesses.

Equation (2) can be used to obtain the permeability coefficients from the transmissivity tests. For this, the geotextile specimen's thickness under each applied normal stress should be measured.

$$k_p = \theta_{\sigma} / T_{\sigma} \quad (2)$$

Where,  $k_p$  is the permeability coefficient (cm/s), and  $\theta_{\sigma}$  and  $T_{\sigma}$  are transmissivity (cm<sup>2</sup>/s) and thickness (cm) of geotextile in each normal stress ( $\sigma$ ), respectively.

To observe the effect of using multiple layers of geotextiles on the transmissivity values, transmissivity tests were repeated with two and three layers of each type of geotextiles. As seen in Fig. 7, with increasing the number of layers up to three, the transmissivity in each constant normal stress increases in rough proportion to the overall thickness.

Table 2. Chemical composition of Natural Pozzolana

	GRADIENTS	
	i	$\theta_{10}/\theta_{1000}$
Geotextile	0.5	76.42
2.MS.1 Layer	1	71.52
	3	65.18
Geotextile	0.5	71.64
4.IG.1 Layer	1	64.87
	3	60.09
Geotextile	0.5	33.12
5.BN.1 Layer	1	29.36
	3	26.01
Geotextile	0.5	32.85
8.IG.1 Layer	1	27.16
	3	21.9

### 3.2. Results of permittivity tests

The results of permittivity tests can be expressed in terms of permeability coefficient, permittivity value ( $\psi$ ), rate of discharge for a particular hydraulic loss, or hydraulic gradient at a certain flow velocity [11]. Here the permittivity value ( $\psi$ ) is of concern. To measure the permittivity of geotextiles, using Equations 3 and 4 the flow rate and the velocity of water across the specimens during the tests are calculated [17].

$$V = Q/A \quad (3)$$

$$\psi = V/\Delta h \quad (4)$$

Where  $\psi$  is permittivity ( $s^{-1}$ ),  $V$  is velocity (cm/s),  $\Delta h$  is the measured hydraulic head loss across the specimen (cm),  $Q$  is flow rate of water passed through specimen ( $cm^3/s$ ), and  $A$  is area of the specimen perpendicular to the direction of flow ( $cm^2$ ). Due to importance of the effect of temperature on the permittivity and according to ASTM D 5493, permittivity values are corrected for  $20^\circ C$  [15]. Variations of geotextile's permittivity with normal stress are illustrated in Fig. 8. As can be seen in this figure, the effect of stress ( $P$ ) on the permittivity value becomes smaller as the thickness of geotextile becomes larger.

The effect of increasing the number of layers of geotextiles in permittivity response for geotextile 5.BN is shown in Fig. 9. As observed in Figs. 8 and 9, permittivity decreases with increasing the normal stress.

Variations of the flow velocity versus hydraulic head loss for geotextile 5.BN are presented in Fig. 10

Fig. 10 shows at each constant velocity with increasing the

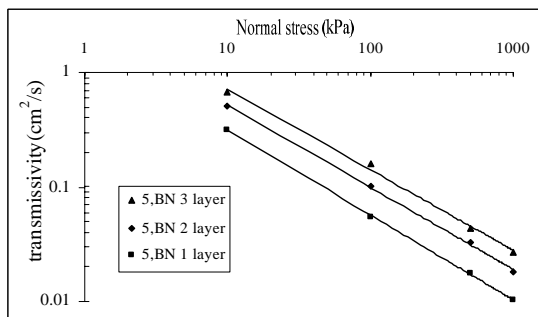

Fig. 7. Results of transmissivity for 1, 2 and 3 layers of geotextile 5.BN under hydraulic gradients of 1

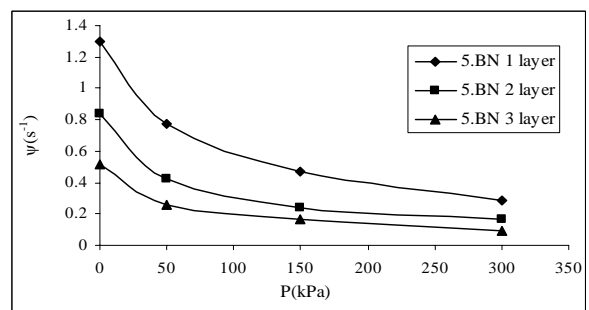

Fig. 9. Results of permittivity for 1, 2 and 3 layers of geotextile 5.BN

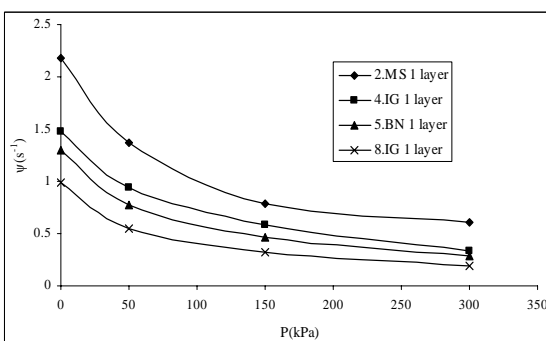

Fig. 8. Results of permittivity for geotextile samples

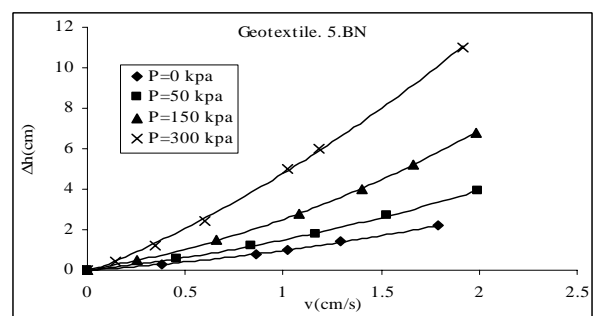

Fig. 10. Variation of velocity versus hydraulic head loss for geotextile 5.BN

normal stress, the hydraulic head loss across the specimen increases.

Velocity variation versus loss of the hydraulic head can be utilized to determine the flow regime in geotextile specimens. In this regard, after plotting the variation of the flow velocity versus hydraulic head loss in logarithmic scales, according to Equation 5 and using Table III, one can determine the type of flow regime in each case [11].

$$\Delta h = av^b \quad (5)$$

Review of power relation between velocity and hydraulic head loss for various types of geotextiles in this study show that the value of  $b$  in Equation 5 varies between 1.22 and 1.47. So flow regime is not turbulent in any of the specimens and in most cases is transient.

### 4. Predictions versus observations of geotextile permeability under confinement

The test results can be used for evaluating the accuracy of expressions for estimation of geotextile permeability, some of them developed and proved accurate for geotextiles under unconfined situations. Thus with comparison of the results of experiments with these theoretical relations one can examine their accuracy under confined situations. Some of these expressions are tabulated in Table IV.

In Table IV Equation 1 is based on Capillary tubings theory for permeability in porous and granular media and can be used for prediction of permeability of geotextiles [18]. Equation 2 has been proposed by Lord for air flow through a fibrous

**Table 3.** Determination of flow regime according to equation (5)

Flow Regime	<i>b</i>
Turbulent	2
Transient	>1 or <2
Laminar	1

**Table 4.** Some of the presented solutions for prediction of permeability of geotextiles

Number of equation	Equation	Source	Remarks
1	$k = g d_f^2 n^3 / 80 \nu (1-n)^2$	Carman-Koseny(1938)	-
2	$k = \rho_w g n^5 d_f^2 / 17.72 \eta_w (1-n)^{1.32}$	Lord(1955)	$n > 0.75$
3	$k = d_f (d_f + d_{avg}) g \rho_w g / \eta_w A$	Rollin et al.(1982)	A=C <sub>D</sub> *Re, A=8-10 for nonwovens
4	$k = \beta \rho_w g n^3 d_f^2 / 16 \eta_w (1-n)^2$	Giroud(1996)	$\beta = 0.11$ for nonwovens

Notes: *k*=permeability, *g*=acceleration of gravity, *d<sub>f</sub>*=geotextile fibre diameter, *n*= geotextile porosity,  $\nu$ =cinematic viscosity of water,  $\rho_w$ =density of water,  $\eta_w$ =dynamic viscosity of water, *d<sub>avg</sub>*= the average distance between geotextile fibres, *A*= is the product of the fluid drag coefficient and the Reynolds number,  $\beta$ =shape factor.

medium that has previously been applied to geotextiles [19]. The last two equations in this table are exclusively developed for determining the permeability of geotextiles [20,21]. The results of comparisons between measured and predicted values of geotextile normal permeability using these four equations for geotextile 5.BN is presented in Fig. 11.

As shown in Fig. 11 in most cases significant deviations exist between predictions and measurements but a very good agreement can be seen between test results and predictions by Equation 4.

### 5. Anisotropy of geotextile permeability

Results from permittivity and transmissivity tests under different confining pressures allow the assessment of the geotextile permeability anisotropy with the stress level. Fig 12 shows a marked anisotropy for the geotextile 2.MS

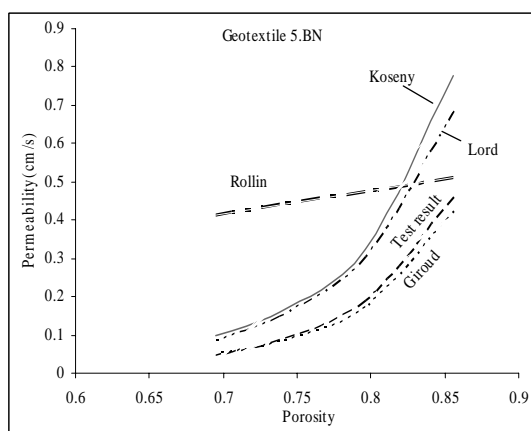

**Fig. 11.** Comparisons between test results and predictions for permeability of geotextile

tested for stress levels below 50 kPa. As the normal stress increases, geotextiles tend to show a more isotropic behaviour with regard to permeability.

In Figs 13 and 14 variations of porosity and thickness of geotextile 5.BN with normal stress are presented, respectively. The investigation of the results of the tests shows a good agreement between permittivity and transmissivity tests for measuring these physical properties.

### 6. Conclusions

In this study some hydraulic and physical properties of several needle punched nonwoven geotextiles were investigated. The obtained results demonstrate the importance of considering site conditions such as applied

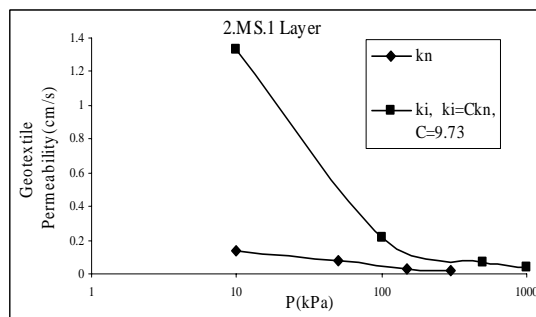

**Fig. 12.** Permeability coefficients versus normal stress for geotextile 2.MS

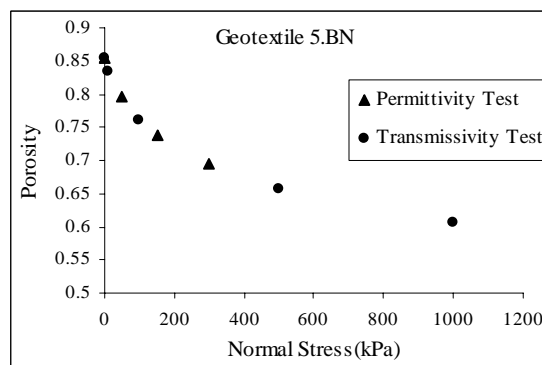

**Fig. 13.** Porosity versus normal stress for geotextile 5.BN

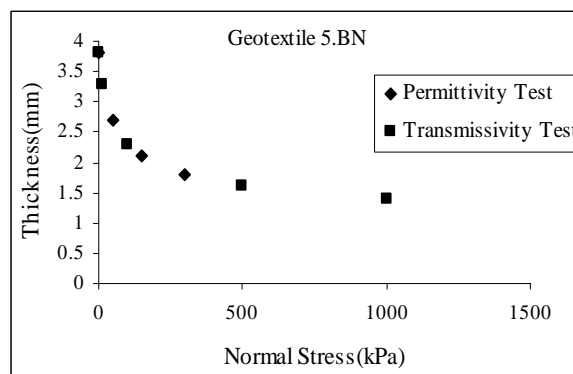

**Fig. 14.** Thickness versus normal stress for geotextile 5.BN

stresses and hydraulic heads on the behavior of geotextiles. The results show that transmissivity decreases exponentially with increasing the normal stress until a residual value is reached, and the rate of decreasing the transmissivity due to increase of normal stress is significant for normal stresses lower than 100kPa. Flow rate and velocity in permittivity tests increase linearly and quadratic in laminar and non laminar flow, respectively. Permittivity and transmissivity values in each case were seen to decrease with increasing hydraulic gradient.

Regarding the results, in-plane and normal to the plane permeability of geotextiles are not unique values and change with changing the boundary conditions of the site. The comparison between predicted and observed geotextile permeability values under various confining stresses confirmed that in most cases these predictions have significant deviations from the results of the experiments, therefore performing the experimental tests is the best solution for determining the hydraulic behavior of geotextiles in different situations. Hence for practical implications, where geotextiles are used for their drainage and filtration properties, such as embankments and/or other hydraulic structures, the real permeability should be obtained based upon experiments using actual boundary conditions and confining stresses.

## References

- [1] Abdi, M.R., Parsapajouh, A., and Arjomand, M.A.: 2008, Effects of random fiber inclusion on consolidation, hydraulic conductivity, swelling, shrinkage limit and desiccation cracking of clays, *International Journal of Civil Engineering*, Vol. 6, No. 4.
- [2] Abdi, M.R., Sadrejad, S.A., and Arjomand, M.A.: 2009, Clay reinforcement using geogrid embedded in thin layers of sand, *International Journal of Civil Engineering*, Vol. 7, No. 4.
- [3] Nayeri, A., and Fakharian, K.: 2009, Study on pullout behavior of uniaxial HDPE geogrids under monotonic and cyclic loads, Vol. 7, No. 4.
- [4] Leflaive, E., and Puig, J.: 1977, Description, propriétés de base et propriétés particulières des textiles pour les applications géotechniques, *C.R.Coll. Int. Sols Textiles*, Vol.3, pp. 353-357, Paris.
- [5] Koerner, R.M. And Sankey, J.E.: 1982, Transmissivity of Geotextile and Geotextile/Soil Systems, Proc. Second Int. Conf. On Geotextiles, IFAI Publishers, St. Paul , Minneapolis 173-6, Las Vegas, USA.
- [6] Koerner, R.M., Bove, J.A., and Martin, J.P.: 1984, Water and Air Transmissivity of Geotextiles, *International Journal of Geotextiles and Geomembranes*, Vol. 1, No. 1, 57-74.
- [7] Adolphe, D., Lopes, M., and Sigli, D.: 1994, Experimental Study of Flow Through Geotextiles, *Laboratoire de Physique et Mécanique Textiles, Textile Research Journal*, Vol. 64, No. 3, 176-182.
- [8] El-Gamal, M.A.L., and El-Shafey, T.M.: 2000, Performance of Drainage Geotextiles for Sustainable Development of Soil and Water Resources in Egypt, *ICEHM2000*, 1-13, Cairo University, Egypt.
- [9] Jeon, H.Y., Kim, S.H., Chung, Y.I, Park, Y.M., and Chung, C.G.: 2003, Analysis of the drainage performance of geotextile composites under confined loads, *Polymer Testing* ,Vol 23, Issue 2, 239-244.
- [10] Narejo, D.B.: 2005, Determination of transmissivity of synthetic drainage materials at low gradients, *Geotextiles and Geomembranes*, Vol. 23, Issue 6, 534-539.
- [11] Van der Sluys, L., and Dierickx, W.: 1987, The Applicability of Darcy's Law in Determining the Water Permeability of Geotextiles, *National Institute of Agricultural Engineering, Geotextiles and Geomembranes* 5, 283-299.
- [12] Kutay, M.E., and Aydilek, A.H.: 2005, Filtration Performance of Two-Layer Geotextile Systems, *Geotechnical Testing Journal*, Vol. 28, Issue 1.
- [13] Ionescu, A., And Kellner, L.:1982, About Longitudinal Permeability and Drainage Capacity of Nonwoven Geotextiles, Proc. Second Int. Conf. On Geotextiles, IFAI Publishers, St. Paul, Minneapolis1, 127-132.
- [14] Palmeira, E.M., and Gardoni, M.G.: 2002, Drainage and filtration properties of non-woven geotextiles under confinement using different experimental techniques, *Geotextiles and Geomembranes*, Vol. 20, Issue 2, 97-115.
- [15] Hufenus, R., and Schrade, U.: 2006, An optimized method to measure the hydraulic conductivity of geosynthetics under load, *Geotextiles and Geomembranes*, Vol. 24, Issue 4, 243-253.
- [16] ASTM D 4716.: 1987, Standard Test Method for Constant Head Hydraulic Transmissivity (In-Plane Flow) of Geotextiles and Geotextile Related Products.
- [17] ASTM D 5493.: 1993, Standard Test Method for Permittivity of Geotextiles Under Load.
- [18] Gourc, J.P., Faure, Y., Rollin, A., and Lafleur, J.: 1982, Structural permeability law of geotextiles, *Second International Conference on Geotextiles*, Vol. 1, 149-154.
- [19] Palmeira, E.M., and Gardoni, M.G.: 2000, The influence of partial clogging and pressure on the behavior of geotextiles in drainage systems, *Geosynthetics International* 7, 403-431.
- [20] Rollin, A., Masounave, J., and Lafleur, J.: 1982, Pressure drop through non woven geotextiles: a new analytical model, *Second International Conference on Geotextiles*, Vol. 1, 161-166.
- [21] Giroud, J.P.: 1996, Granular filters and geotextile filters, In Lafleur, J., and Rollin, A., Editors, *GeoFilters'96*, 565-68, Montreal, Canada.