

Responses of isolated building with MR Dampers and Fuzzy Logic

F. Khoshnoudian^{1,*}, A. Molavi-Tabrizi²

Received: January 2011, Revised: January 2012, Accepted: June 2012

Abstract

The application of fuzzy algorithms in the response control of a base isolated building with MR dampers is investigated in this paper. Most of the previous researches in this field have been focused on fuzzy algorithms with linear membership function however in the current study; the membership functions are assumed to be Gaussian and their effectiveness is studied. For this purpose, an eight-story building with regularity in plan and height is considered. The adopted base isolation system includes linear bearings and control devices for improving the behavior of isolated structure under near field ground motions. MR dampers are used to reduce base displacements and have the capacity of 1000 kN with the maximum applied voltage of 10 V. In order to verify the control procedure and analyzing the structure, a simulation procedure is developed. This procedure performs linear analysis of the structure in presence or in absence of the base isolation system. Moreover, the simulation procedure is able to appropriately determine the MR damper voltage using fuzzy logic algorithms and then analyzing the whole system too. Finally, seven near-field earthquake records are chosen in order to study the structure responses under these records and the obtained results demonstrate the accuracy of proposed control procedure.

Keywords: Semi-active control, MR damper, Near-field earthquakes, Base-isolated building, Fuzzy control algorithm.

1. Introduction

Base isolation systems are one of the most famous and effective devices to control the response of the structures under earthquake excitations and many full scale buildings are currently implemented with these passive control devices [Soong and Constantinou, 1994, Soong, and Dargush, 1997, Skinner, Robinson and McVerry, 1993]. These devices reduce the responses of the superstructure, especially the inter-story drifts and floor accelerations; in contrast, the base displacements under near-field ground motions may be increased. To alleviate this problem, base isolation systems are armed with active and semi-active control devices. Presently, many hybrid-type base isolation systems have been analytically and experimentally studied and the efficiency of the active or semi-active devices to reduce the base displacements has been investigated. Active control devices have been fully embraced by the engineers, because there are still concerns about their

stability due to large power supplies. Semi-active control devices such as MR (magneto rheological) dampers or yield dampers have better performance than active systems relieved from the burden of exploiting large power sources [Jung, Choi, Spencer and Lee, 2005]. The optimum location for yielding dampers is studied by comparison between benefit to cost ratio, drift stories and the number of ADAS types of various distributions. The amount of dissipation energy by dampers located in different levels and the status of plastic hinges in main members are confirmations to the optimum design for the location of dampers [M.H. Sebt, A. Yousefzadeh and M. Tehrani Zadeh Haghifhifar, 2011]. MR dampers are a class of controllable fluid dampers where the shear force of the fluid is controlled by an external magnetic field. The control input variables of these dampers are current and voltage. The voltage or the current makes a magnetic field which its magnitude causes the particles in the MR fluid to become polarized and consequently, the shear stiffness of the MR fluid and the stiffness of the base isolation system change. Many investigations have been conducted on controlling MR dampers. Several algorithms have been proposed to find the optimum and suitable value of voltage or current which controls the damper. Modified clipped-optimal algorithm, modulated homogeneous friction algorithm, maximum energy dissipation

* Corresponding Author: khoshnud@aut.ac.ir
1 Associate professor, Department of Civil Engineering, Amirkabir University of Technology, Hafez st., Tehran, Iran
2 MSc graduated, Department of Civil Engineering, Amirkabir University of Technology, Hafez st., Tehran, Iran

algorithm and fuzzy control algorithm are proposed to mitigate the base displacement of benchmark base-isolated buildings and the performance of these algorithms has been evaluated [Narasimhan., Nagarajaiah., Johnson and Gavin, 2006]. In case of fuzzy control, Jung et al. [Jung, Choi, Spencer and Lee, 2005] used a fuzzy logic controller with linear functions to control the MR damper. Lafontaine et al. [Lafontaine., Moroni., Sarrazin. and Roschke, 2008] used fuzzy control and genetic algorithms to improve the responses of a four-story base-isolated building. The aim of the investigation is to minimize the acceleration of the roof and it has been achieved by determining the optimum voltage to be applied to the MR damper at each instance of time. Chin-Hsiung Loh et al. [Loh Chin-Hsiung, Wu L. Y. and Lin P.Y., 2003] have adopted fuzzy logic algorithm with linear membership functions to control the displacement of a base isolated building with MR dampers. The obtained results indicate that the established control algorithm is useful to reduce displacements and acceleration responses.

In the current paper performance of fuzzy logic algorithm with assuming Gaussian membership functions in the response control of a base isolated building is investigated. For this purpose first, an structural model of a building is developed and then responses of the structure in presence and in absence of the base isolation system and control device is obtained. In simulation procedure a fuzzy logic algorithm using Gaussian membership function has been developed to determine the input voltage to MR damper. Fuzzy logic is a suitable way for fast decisions and acceptable accuracy. In addition choosing the appropriate membership function in fuzzy algorithms plays a vital role to achieve the appropriate results and in this investigation the performance of Gaussian membership function is demonstrated.

2. Structural model

A fixed base building, a base isolated building, and a hybrid base isolation building have been studied and compared in this paper [Molavi-Tabrizi., 2009]. First, a fixed base structure is

analyzed and its responses such as stories displacement and acceleration are recovered, then a high damping rubber bearing (HDRB) is joined to this structure and after MR damper is added to the base isolation system to make a hybrid system; finally, their performances were compared in order to show the ability of proposed fuzzy logic algorithm.

The studied building is an eight-story steel braced frame structure. The plan of the building is rectangular with 42 m long and 30 m wide, regular in height and plan. Plan of the building and the location of the bracing systems are shown in Fig. 1. In base-isolated building the steel superstructure is supported on a reinforced concrete base slab and it is integrated with concrete beams below, and drop panels under each column location. The High Damping Rubber Bearings (HDRB) are connected between these drop panels and the footings below. Details of this connection are illustrated in Fig. 1.

The superstructure is modeled as a 3D linear elastic system and all the structural members, such as beams, columns and bracings are idealized in details. It is noted that the 3-D modeling is studied in order to idealize more realistic model of super-structure. Floor slabs and the base are assumed to be rigid, so each story has three degrees of freedom at the center of mass. Therefore, the superstructure and the isolation system consist of 27 degrees of freedom. The superstructure damping ratio is assumed to be 5% for all modes. All the using sections for structural elements have been shown in Table 1 and the structural model's characteristics are tabulated in Table 2.

3. Base isolation and MR damper models

The base isolation system includes HDRB which is used under each column of the structure. The isolators are assumed to be linear and have been modeled by their effective stiffness. The damping ratio of the isolators are assumed to be 10%.

The target period of the structure is taken 3 seconds and the effective stiffness of the isolation systems calculates by :

$$K_{eff} = 4\pi^2 \frac{M}{T_B^2} \quad (1)$$

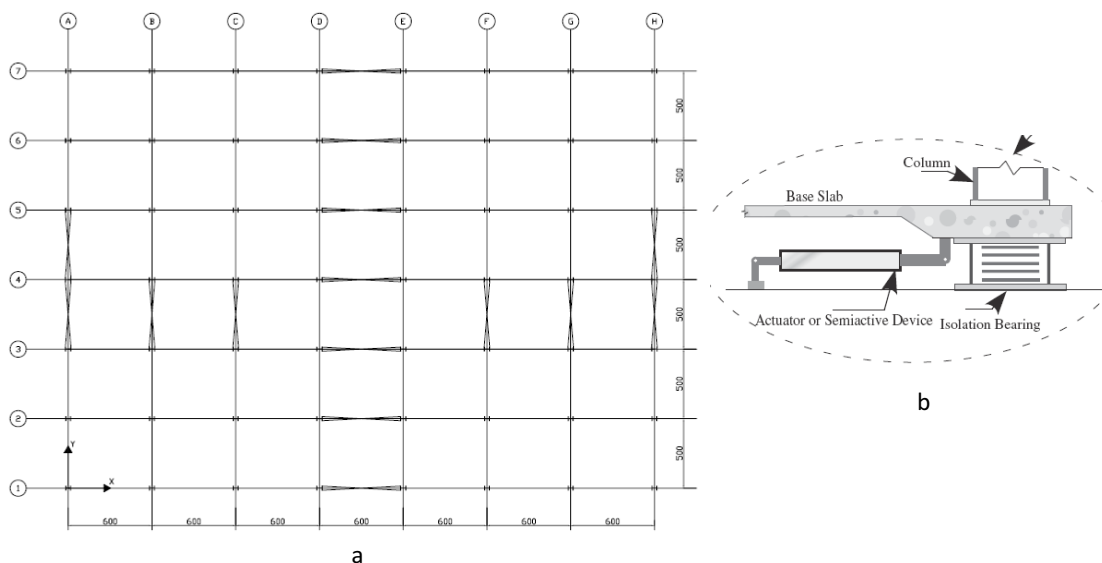

Fig. 1. a) Plan of a building; b) base isolation system and MR damper [Narasimhan., Nagarajaiah., Johnson and Gavin HP,2006]

Table 1. Structural elements

Columns	H300,H360,H400
Beams	IPE160,IPE200,IPE400
Braces	2UNP200,2UNP280
Joists	IPE220

Table 2. Natural period of the structure

No.	X direction	Y direction	Torsion
1	2.0429	2.0057	1.529
2	0.7216	0.7119	0.5403
3	0.4681	0.4638	0.3696
4	0.3654	0.3501	0.2755
5	0.2533	0.2520	0.2352
6	0.2310	0.2180	0.2114
7	0.1906	0.1834	0.1829
8	0.1766	0.1635	0.1377

In which K_{eff} is the effective stiffness of the isolator, M is the total mass of the superstructure and T_D is design period of the system.

MR dampers are employed to control the base displacement of the building. In order to predict the behavior of MR dampers, an appropriate modeling is essential. A simple mechanical model consisting of a Bouc-Wen element in parallel with a viscous damper (Fig. 2) has proposed to predict the behavior of a shear-mode MR damper over a wide range of inputs in a set of experiments [Dyke., Y_i , F . and Carlson, 1999]. The equations governing the force predicted by this model are:

$$f = c \dot{x} + \alpha z \quad (2-a)$$

$$\dot{z} = -\gamma |\dot{x}| z |z|^{n-1} - \beta \dot{x} |z|^n + A \dot{x} \quad (2-b)$$

Where x and \dot{x} is the displacement and velocity of the damper respectively, z is the evolutionary variable that accounts for history dependence of the response and f is the force that provides by damper. By adjusting the parameters of the model γ , β , n and A , one can control the linearity in the unloading and the smoothness of the transition from the pre-yield to the post-

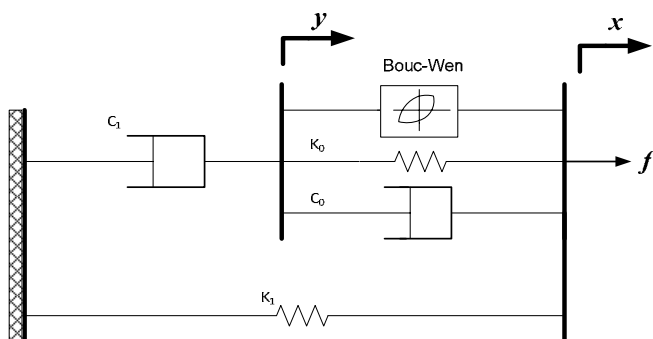
**Fig. 2.** Simple model of MR damper

yield region. The functional dependence of the device parameters on the effective voltage u is modeled as:

$$\alpha = \alpha_a + \alpha_b u \quad (3-a)$$

$$c = c_{0a} + c_{0b} u \quad (3-b)$$

α , c , α_a , α_b , c_{0a} and c_{0b} are the model parameters.

In addition, the current driver circuit of MR damper introduces dynamic effects into the system. These dynamics are typically considered to be a first-order time lag in the response of the device to change in the command input. These dynamics are accounted with the first-order filter on the control input given by;

$$\dot{u} = -\eta(u - v) \quad (4)$$

Where v is the command voltage applied to the control circuit and $1/\eta$ is the time constant of this first-order filter.

The parameters of the MR damper were selected so that the device has a capacity of 1000 kN, as follows: $\alpha_a = 1.0872e5$ N/cm, $\alpha_b = 4.9616e5$ N/(cm.V), $c_{0a} = 4.40$ N.s/cm, $c_{0b} = 44.0$ N.s/(cm.V), $n = 1$, $A = 1.2$, $\gamma = 3$ cm⁻¹, $\beta = 3$ cm⁻¹ and $\eta = 50$ s⁻¹. These parameters are based on the identified model of a shear-mode prototype MR damper tested at Washington University and scaled up to have a maximum capacity of 1000 kN with maximum command voltage $V_{max} = 10$ V [Yoshida, and Dyke, 2004.]. This MR damper with this capacity of force has been chosen because of the amount of the structure base shear.

4. Fuzzy control

Fuzzy logic is a way to decide the best between some choices which do not need so much precision but speed to react in time. Due to this introduction, this control system unable to solve problems that require high precision; such as shooting precision laser beams over tens of kilometers in space or focusing a microscopic electron beam on a specimen with the size of a nanometer. But small human problems required such precision. Problems such as parking a car, navigate a car among others on a freeway, washing clothes and etc.

Hence, fuzzy systems are very useful in two general contexts. First, situations involving highly-complex systems with not fully understood behaviors. Second, situations where an approximate, but fast, solution is warranted [Thimothy, 2004].

Making decision of fuzzy control is based on "if-then" rules. The procedure of controlling by fuzzy algorithms has three steps: (1) Fuzzification, where the inputs are converted to fuzzy linguistic values using membership functions. (2) Decision making, in this part by using "if-then" rules the algorithm make decision about the value of the output. (3) Defuzzification, where the fuzzy output is converted to a crisp value [Wilson. and Abdullah, 2005].

In this study a Sugeno fuzzy controller is used to decide the input voltage of the MR dampers. The input set of the controller includes velocity and displacement of the structure base. These variables are normalized to 1 and -1, and also distributed by three Gaussian membership functions. The velocity and displacement were normalized by the absolute

maximum velocity and displacement at the base respectively. The letters N, Z and P which are used in the membership functions and fuzzy rules with the meaning of negative, zero, and positive, respectively (Fig. 3).

The output of the controller will be either 0 or 0.5, or 1 which is shown by Z or M or L, respectively. These numbers will be the input voltage of MR damper before defuzzification, indeed we need to scale them to a real voltage and according to MR damper voltage capacity, and it will be between 0 to 10 V. The more amounts of voltage, the greater force and the behavior of the structure goes to fixed base structure and vice versa. So according to the aim of structural control, choosing the correct and suitable output scale factor is so crucial. It is noted that in this investigation Sugeno fuzzy system was used for the membership function of outputs and this system is similar to Mamdani fuzzy system in the fuzzification step where the inputs are converted to fuzzy linguistic values using membership functions, but the membership function of outputs is not identical. In the Sugeno fuzzy system, the membership function of outputs is linear or constant (Zhao and Collins, 2003). In the current paper, we assumed that the membership function of outputs are defined in the interval $[0, 1]$ with three constant values 0, 0.5 and 1, corresponding to Z, M, L respectively. These values represent zero, average and maximum value respectively.

Hysteretic behavior of MR damper under $20\sin\pi t$ loading with frequency 0.5Hz assuming various voltages from 0 to 10 V are illustrated in figure 4.

The rules which are used in this study have been shown in Table 3. The performance surface of fuzzy controller has been shown in Fig. 5 and the diagram which is shown in Fig. 6 illustrates the steps of fuzzy control algorithm. It is noted that

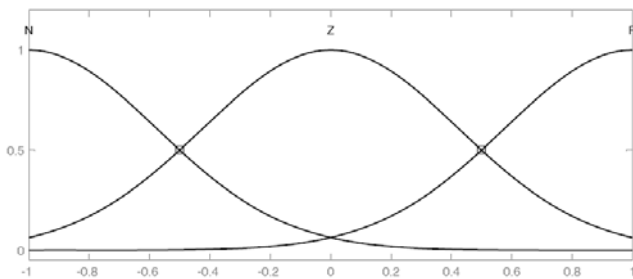

Fig. 3. Gaussian input membership functions

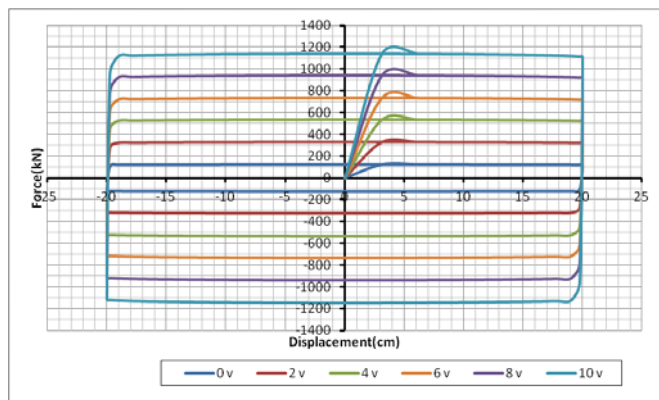

Fig. 4. Force damper in function of displacement for various voltage under mentioned excitation

Table 3. fuzzy rules

		Displacement		
		N	Z	P
Velocity	N	L	M	Z
	Z	M	Z	M
	P	Z	M	L

first the structure is excited by earthquake excitation and then the response of structure can be obtained. These responses include displacement, velocity and acceleration of the base and stories. Among these values, the velocity and displacement of the base are recorded in each step of time and are sent to the fuzzy controller and the MR damper. K_d and K_v are the fuzzification factors for the input data. The controller processes the data and by using the fuzzy rules chooses the suitable voltage to send it to MR damper. K_u is the defuzzification factor. MR damper creates a force which acts on base level by using these voltages, then the structure is reanalyzed and the new responses are recovered.

It is noted that to normalize input variables, scaling factors were employed for displacement and velocity respectively (figure 6). Since the output universe of discourse was also normalized, a scaling factor K_u is required because scaling factors are responsible for mapping inputs and outputs to universes of discourse, they have a large effect of controller's performance. K_u or defuzzifier factor was supposed 7 since the maximum voltage would be limited to 7 v. On the other hand since the output's universe of discourse was normalized, defuzzifier factor was required and chosen as $K_u=7$.

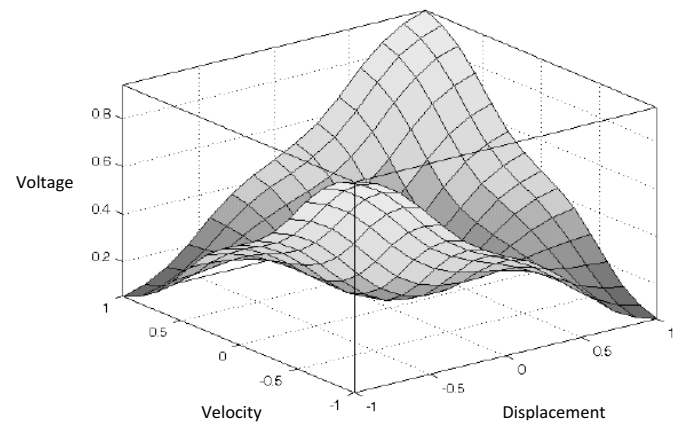

Fig. 5. Performance surface of fuzzy logic controller obtained from matlab

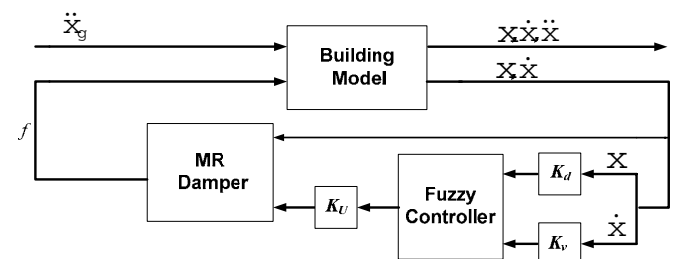

Fig. 6. control strategy of structure

5. Earthquake records

In this study seven near-field records have been used and scaled up to 1.0 g. These records were selected from strong ground motion database of the pacific earthquake engineering research (PEER) centre. The selected ground motions were near field record, and corresponded to locations were less than 12 Km from rupturing faults. Also the soil at the site corresponds to NEHRP site class D. Then the average response is used to investigate the effect of MR dampers on seismic behavior of isolated building. The properties of these records are shown in Table 4.

6. Simulation procedure and results

An analytical procedure is developed by using Matlab in order to analyze and to control the performance of MR damper by employing the fuzzy algorithm. In this procedure, mass, stiffness, and damping matrixes of the structure are imported as input data and the equilibrium equations for the structure are solved. The base isolation systems are modeled linear with its effective stiffness. The MR damper idealized by equation (2) to (4) and the force applied to the center of stiffness of the base. The input parameters such as the mass and stiffness matrixes are obtained from ETABS program which is used for initial modeling of the structure. The mass matrix is gained due to dead and live load of the structure.

Table 4. Earthquake records

No.	Earthquake	PGA	Magnitude	Closest distance(km)
1	KOBE	0.7105	6.90	0.96
2	LOMA-PRIETA	0.4446	6.93	5.02
3	TABAS	0.8128	7.35	2.05
4	IMPERIAL-VALLEY	0.6861	6.53	2.68
5	NORTHRIDGE	1.4279	6.69	7.01
6	CHI CHI	0.7940	7.62	3.14
7	SAN-FERNANDO	1.1644	6.61	1.81

The maximum voltage of the MR damper can change between 0 and 10 V. The increasing of voltage causes the greater force applies to the structure and the response of the structure is closer to fixed base structure. Therefore, it is so important to decide about the maximum voltage of the damper. To make this decision two parameters must be considered: (1) base displacement of the structure, (2) the relative displacement of roof to base. These parameters are selected as a goal of control system to prevent the impact of building from adjacent structures. These results have been compared in three different situations of fixed base structure, the structure with passive control, and the structure with semi-active control while the input maximum voltage changes from 3 to 10 V.

This range of voltage is selected since the hybrid system operates as a passive base isolated system at the voltage less or equal to 2 V, therefore value of 3 to 10 V has been selected to investigate the performance of MR damper in a hybrid system on the seismic behavior of isolated building. According to the aim of structural control, the optimum maximum voltage can change, in this study the goal of the control is considered to be the reduction of the base displacement against base isolated building and the drift of the roof against fixed base structure equally. So the maximum voltage contemplates to be 7 V. In Fig. 7, the improvements of these quantities are shown versus voltage.

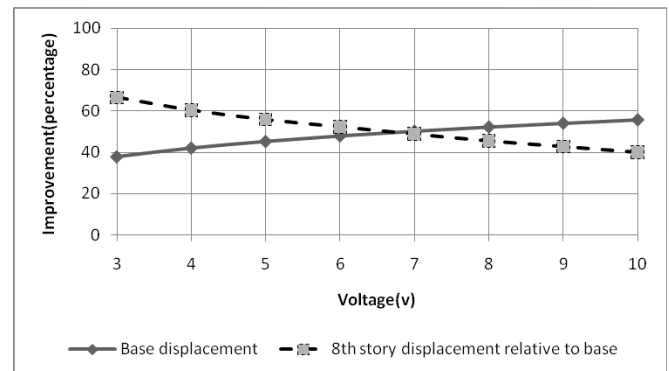

Fig. 7. Improvement of 8th story displacement relative to base versus fixed base structure and base displacement versus base-isolated building.

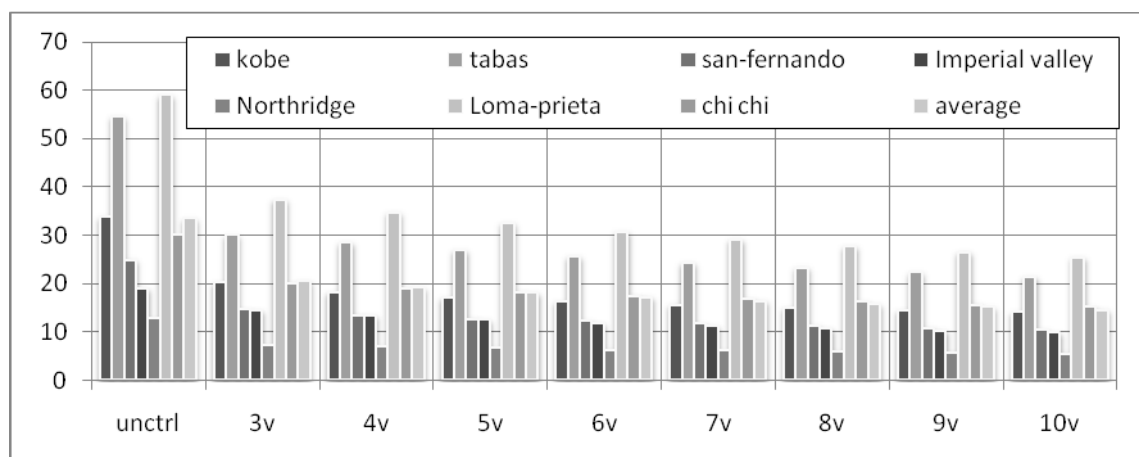

Fig. 8. Base displacement for different voltages and earthquake records

Also these quantities for all the earthquake records have been shown in Fig. 8 and Fig. 9 separately. According to aim of this study, base displacement relative to base isolated building in passive system and roof drift related to fixed-base structure assumed to be considered equally, so the voltage equal to 7 V improves both of them 50% (figure 7). This voltage is selected as an optimum voltage due to aim of control and all the other responses revealed in this voltage. According to figure 8, by variation of the input voltage of MR damper from 3 to 10 V, the base displacement improves from 39% to 58% comparing to passive control situation. Otherwise, increasing of MR damper voltage causes decreasing of base displacement and it can protect the

building from impact to adjacent structures. However, the obtained results from 8th storey drift relative to base for different voltages and earthquake records (figure 9) shows when the voltage of the damper changes from 3 to 10 V, the roof displacement relative to base against the fixed base structure improves from 62% to 40% respectively and it demonstrates the reduction of effect of MR damper on this seismic response of building.

After choosing the maximum voltage, other responses such as story accelerations, story drifts, and base shear of the structure are revealed. To study the effect of voltage on stories acceleration, this response is inspected for all voltages, all the earthquake excitations and also the average (Fig. 10-17).

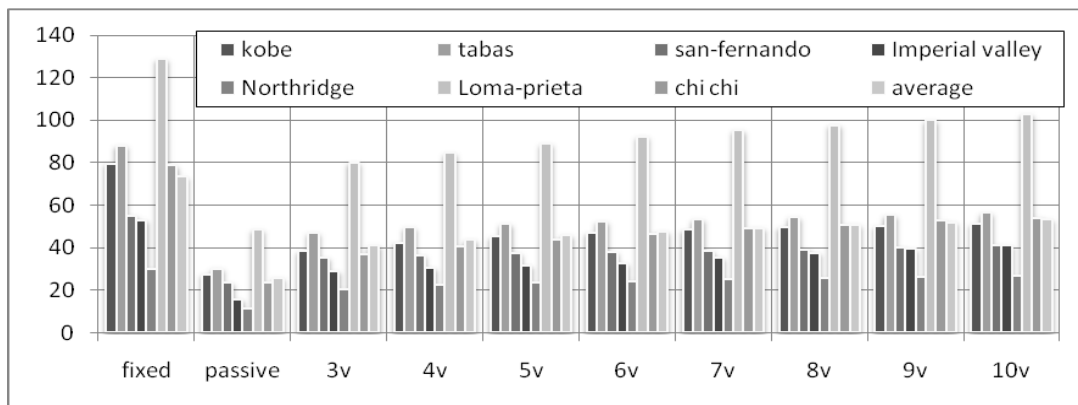

Fig. 9. 8th story drift relative to base for different voltages and earthquake records

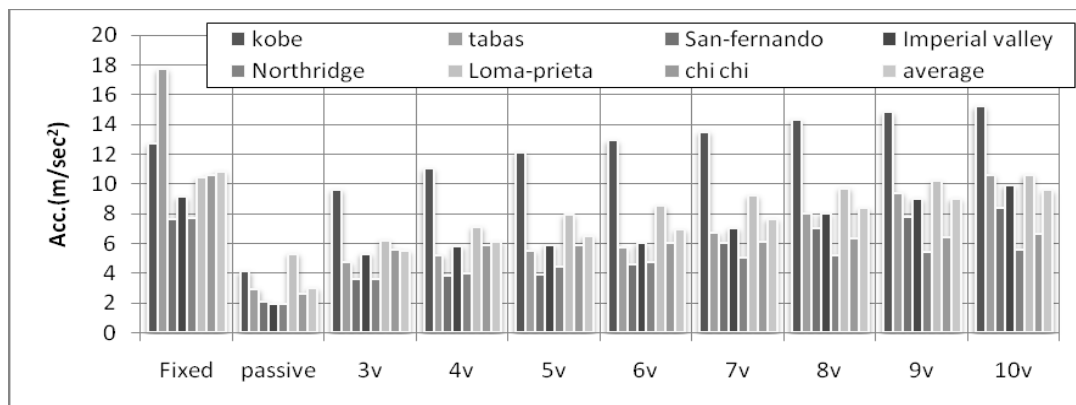

Fig. 10. 1st story acceleration for different voltages and earthquake records

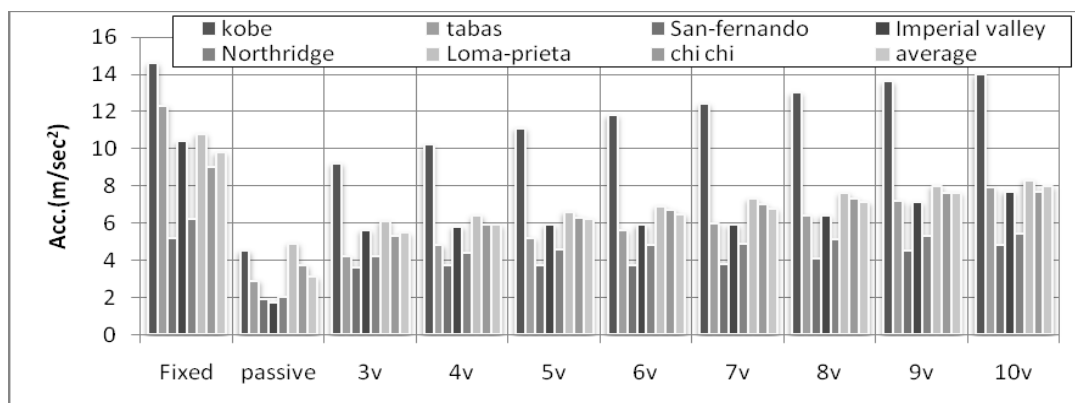

Fig. 11. 2nd story acceleration for different voltages and earthquake records

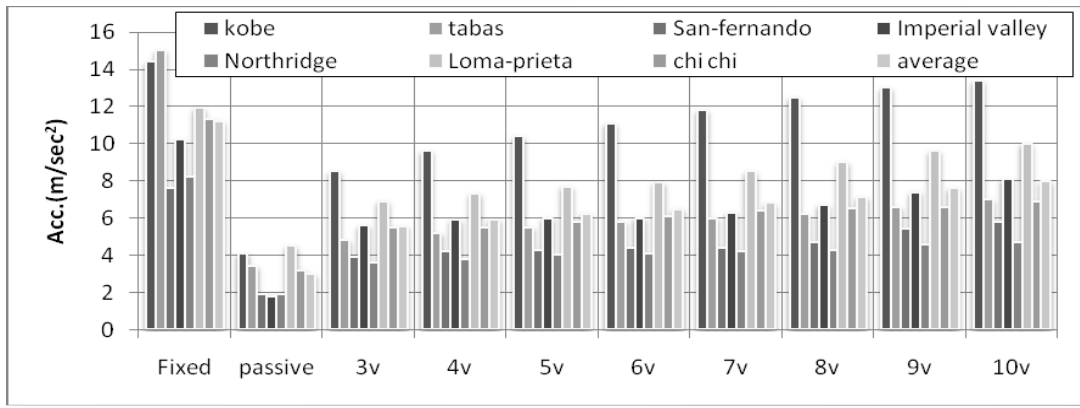

Fig. 12. 3rd story acceleration for different voltages and earthquake records

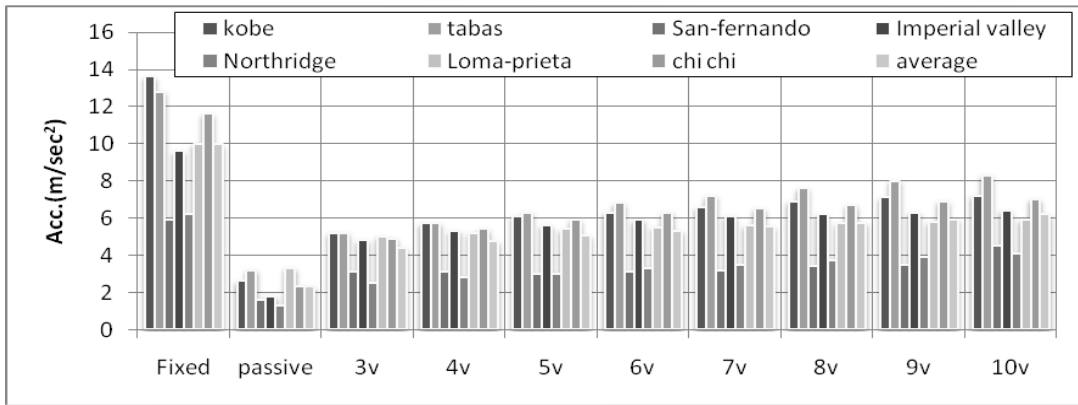

Fig. 13. 4th story acceleration for different voltages and earthquake records

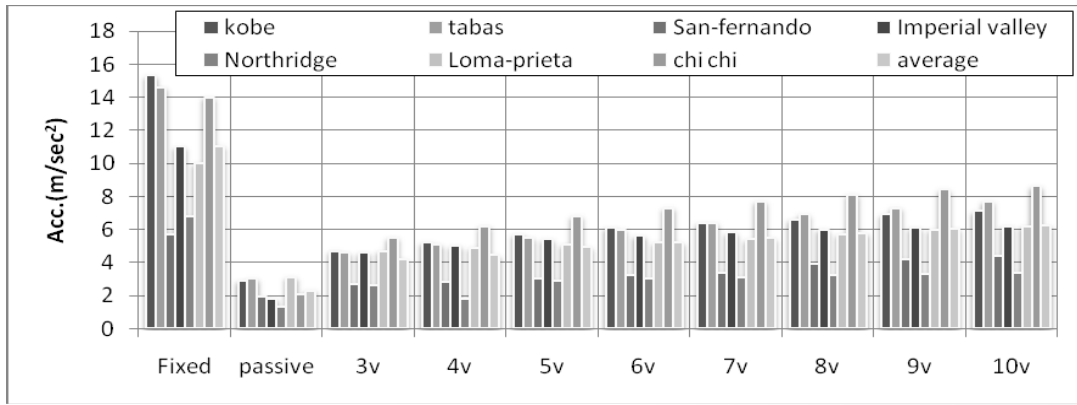

Fig. 14. 5th story acceleration for different voltages and earthquake records

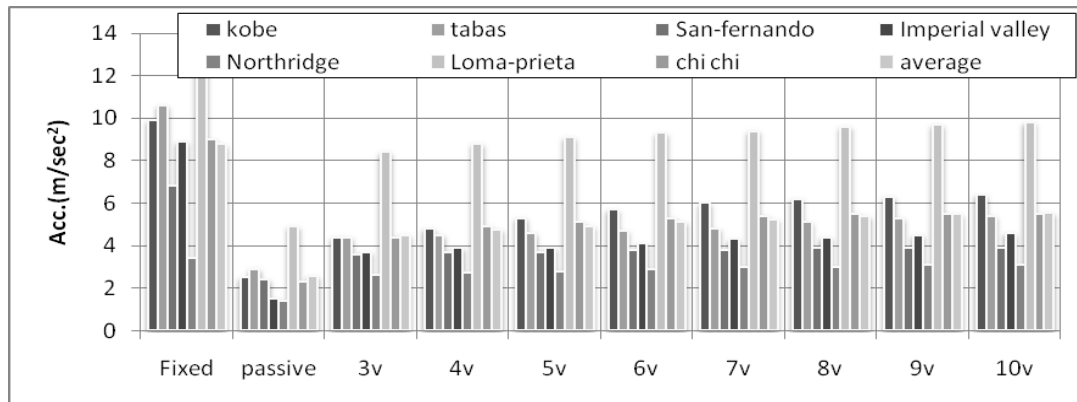

Fig. 15. 6th story acceleration for different voltages and earthquake records

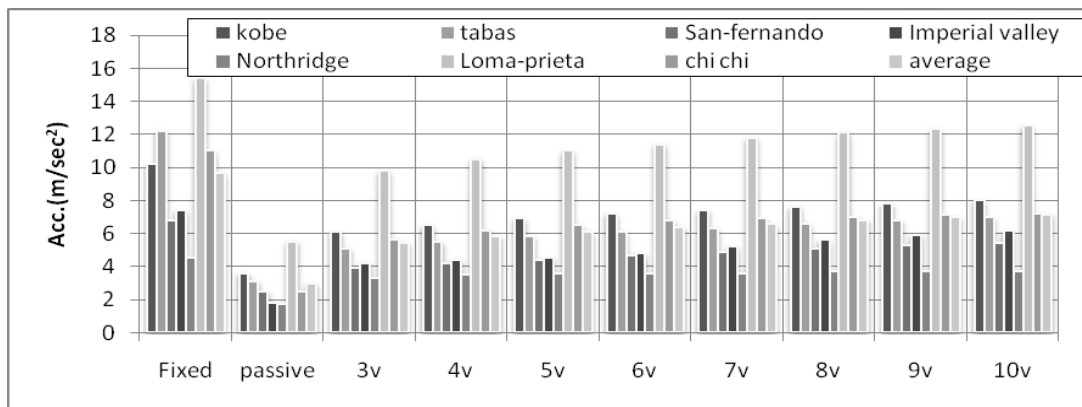

Fig. 16. 7th story acceleration for different voltages and earthquake records

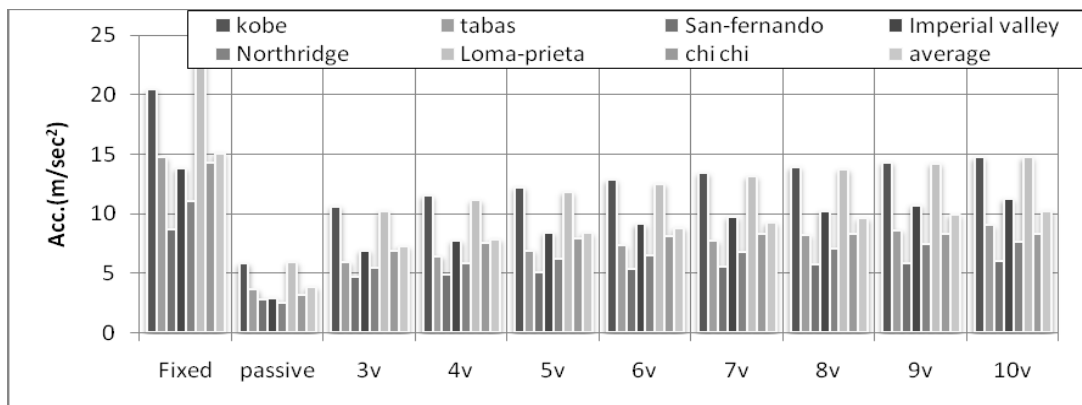

Fig. 17. 8th story acceleration for different voltages and earthquake records

In addition, when input voltage of the MR damper is chosen 7 V, the story drifts and base shear of the structure are shown in Table 5 and Table 6 respectively.

After selecting this voltage as an optimum voltage, some responses were extracted and it is noted that for acceleration responses, the effect of semi-active control is noticeable especially in 1st floor which is 39% and this effect reduces to 12% for 6th floor. Otherwise using MR damper as semi-active control can reduce the floor acceleration too. Setting the maximum voltage limits to 7 V causes reducing story displacements from 32% to 37% in different stories against fixed base building (table 5).

In addition by assuming the maximum possible voltage applied to MR damper to be 7 V, the story drifts improve from 27% to 38% in different stories against fixed base building. The story acceleration in different stories reduces from 32% to 50% versus fixed base structure.

Otherwise using base isolation systems causes reduction of building responses such as drift storey, acceleration and base shear, but base displacement of isolated structure due to flexibility of isolators will increase and using isolator with greater flexibility leads the behavior of super-structure tends to fixed base structure. However the responses of structure and also base displacement can be controlled by using MR damper as semi-active control and consequently to prevent from impact of adjacent structures.

7. Conclusions

This paper focuses on application of a fuzzy logic algorithm in the response control of a base-isolated building with MR damper under near-field earthquake excitations. A fuzzy logic algorithm with Gaussian input membership function is developed to study a hybrid control system with the aim of controlling the displacement of an eight-story base isolated building under seven near-field earthquake excitations. The peak responses of the structure are compared in 3 different cases: (1) a fixed based structure, (2) a base isolated building with passive control strategy and (3) a base isolated building with MR damper.

The results are obtained for different voltages in MR damper and with the aim of reducing base displacement and roof drift to the base for preventing the impact of isolated building to adjacent structures.

Therefore, the maximum possible voltage to be applied to the MR damper was selected to be 7 V and other responses are revealed due this voltage. In this study, stories accelerations reduce 39% in the 1st floor and 12% in sixth floor relative to the fixed-base structure. Also the displacements of the stories were improved 32% to 37% relative to the fixed-base structure. Finally all the results which were presented in this paper show the efficiency of fuzzy control algorithm to reduce the responses of the structure.

Table 5. Story drift for voltage=7 volts

STORY		1 st	2 nd	3 rd	4 th	5 th	6 th	7 th	8 th
Kobe	Fixed	2.95	3.63	2.05	3.1	1.03	3	1.45	2.68
	passive	0.83	0.95	0.53	1	0.8	1.33	0.63	0.83
	semi	1.5	1.65	0.8	2.15	1.3	2.3	1.08	1.35
Tabas	Fixed	3.03	3.43	2.05	4.4	2.33	3.45	1.65	1.7
	passive	1.28	1.48	0.9	1.7	0.73	0.9	0.3	0.25
	semi	2.1	2.6	1.53	3.03	1.13	1.25	0.6	0.85
San-fernando	Fixed	1.45	1.88	1.38	3.35	1.65	2.2	0.8	1.08
	passive	0.6	0.83	0.55	1.38	0.7	1.03	0.38	0.4
	semi	1.08	1.23	0.88	2.08	1.1	1.68	0.7	0.78
Imperial valley	Fixed	2.05	2.28	1.15	1.93	0.95	2.45	0.95	1.48
	passive	0.45	0.58	0.35	0.78	0.43	0.7	0.28	0.35
	semi	1.2	1.48	0.85	1.73	0.7	0.9	0.48	0.85
Northridge	Fixed	1	1.08	0.48	0.58	0.28	1.53	1	1.65
	passive	0.33	0.38	0.28	0.7	0.3	0.4	0.15	0.23
	semi	0.63	0.65	0.38	0.63	0.55	1.58	0.7	0.98
Loma-prieta	Fixed	2.83	3.95	2.8	6.93	3.78	5.98	2.58	3.1
	passive	1.3	1.35	1.05	2.9	1.45	2.23	0.88	0.95
	semi	2.03	2.73	2.13	5.23	2.8	4.4	1.75	2.03
chi chi	Fixed	3.13	3.75	2.38	5.38	2.25	2	0.45	0.33
	passive	0.7	0.9	0.58	1.18	0.6	0.98	0.43	0.48
	semi	1.83	2.05	1.15	3.23	1.38	1.45	0.58	0.58
Average	Fixed	2.35	2.86	1.76	3.67	1.75	2.94	1.27	1.72
	passive	0.78	0.92	0.61	1.38	0.72	1.08	0.44	0.50
	semi	1.48	1.77	1.10	2.58	1.28	1.94	0.84	1.06

Table 6. the ratio of base shear to structure weight in different earthquake records

Imperial-valley			San.fernando			Tabas			Kobe		
S.A	P	F	S.A	P	F	S.A	P	F	S.A	P	F
0.24	0.09	0.40	0.22	0.12	0.28	0.43	0.25	0.59	0.30	0.16	0.57
Northridge			Chichi			Lomaprieta			AVERAGE		
S.A	P	F	S.A	P	F	S.A	P	F	S.A	P	F
0.13	0.06	0.19	0.36	0.14	0.61	0.40	0.27	0.55	0.30	0.16	0.46

References

[1] Dyke, S.J., Yi, F., Carlson, J.D. (1999). Application of magnetorheological dampers to seismically excited structures. Proc., Int. Modal analysis conf., Kissimmee, Fla., February 8-11

[2] <http://peer.berkeley.edu/nga>

[3] Jung, H., Choi, K., Spencer Jr., Lee, I. (2005). Application of some semi-active control algorithms to a smart base-isolated building employing MR dampers. Journal of Structural control and health monitoring, 2(13):693-704.

[4] [4] Loh Chin-Hsiung, V., Wu, L. Y., Lin, P.Y. (2003). Displacement control of isolated structures with semi-active control devices. Journal of structural control 3(10):77-100

[5] Lafontaine, M., Moroni, M.O., Sarrazin, M., Roschke, P. (2008). Optimal control of accelerations in a base-isolated building using semi-active MR damper. The 14th world conference of earthquake engineering, Beijing, China, October 12-17.

[6] Molavi-Tabrizi, A. (2009). The effects of nearfield earthquakes on base-isolated building with smart systems, MSc thesis, Amirkabir University of technology, Department of civil engineering, Tehran, Iran

[7] Narasimhan, S., Nagarajaiah, S., Johnson, EA., Gavin, HP. (2006). Smart base isolated benchmark building part 1: problem definition. Journal of structural control and health monitoring 4(13):573-588.

[8] Soong, T. T., Constantinou, M. C. (1994). Passive and active structural vibration control in civil engineering. New York : Springer-Verlag, , Inc.

[9] Soong, T. T., Dargush, G. F. (1997). Passive energy dissipation systems in structural engineering, New York: John Wiley & Sons, Inc..

[10] Skinner, RI., Robinson, WH., McVerry, GH. (1993). An introduction to base isolation. Wiley: Chichester.

[11] Timothy, J.R. (2004). Fuzzy logic with engineering applications. England : 2nd Edition. John Wiley & Sons Ltd. The Atrium, Southern Gate, Chichester, West Sussex, PO19 8SQ,

[12] Wilson, C.M.D., Abdullah, M.M. (2005). Structural Vibration Reduction Using Fuzzy Control of Magnetorheological Dampers. New York : ASCE Structures Congress, NY.

[13] Yoshida, O., Dyke, J. (2004). Seismic control of a nonlinear benchmark building using smart dampers. Journal of Engineering mechanics, ASCE 4(130):386-392.

[14] Zhao y. and Collins J.r. 2003," Fuzzy PI control design for an industrial weigh belt feeder",IEEE transactions on fuzzy systems, vol 11, No 3, pp 311-319.

[15] Sebt M.H., Yousefzadeh A., Tehrani Zadeh Haghhighifar M. 2011, "Optimal Yielding damper Distribution in Steel Structures with a Cost-Benefit Analysis", International Journal of Civil Engineering, Vol 9, No 1, pp 23-34

Notations

K_{eff} : Effective stiffness of base isolation
 M : Total mass of the structure
 T_D : Design Period of the system
 f : Force produced by MR damper
 x : Displacement of the damper
 \dot{x} : Velocity of the damper

Z : Evolutionary variable of the damper
 $\gamma, \beta, n, A, c, \alpha, \alpha_a, \alpha_b, c_{0a}, c_{0b}$: Damper variables
 u : Effective voltage
 v : Command voltage
 η : Inverse of time constant